



- SEAT PANS
- NARROW SEATS
- SUSPENSION SEATS
- NON SUSPENSION SEATS
- SEAT BELTS
- MICRO SWITCHES
- SPARE PARTS



More than 3000 seats in stock. Also seat parts available!!!

This is a selection of seats & accessories. For all other seats & accessories, contact us.

TECHNICO

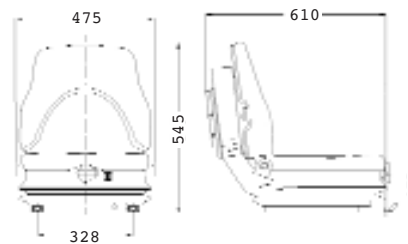

REF 110TA8799 Comfortable suspension seat with slide rails. With weight adjustment (front) and adjustable backrest.

REF 110TA8803 Seat with retractable seat belt.

GRAMMER MSG 20

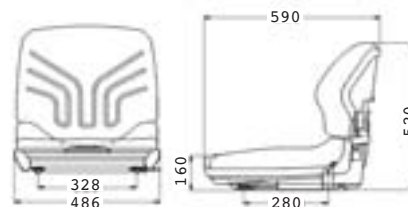

REF 106TA8602

Comfortable suspension seat. With weight, front/rear and backrest adjustment. With seat belt brackets.

REF 110TA8673

Seat with retractable seat belt.

GRAMMER MSG 20 NARROW

narrow



REF 106TA8603

Comfortable suspension seat. With weight, front/rear and backrest adjustment. With seat belt brackets.

REF 110TA8637

Seat with retractable seat belt.

NARROW SEAT

narrow

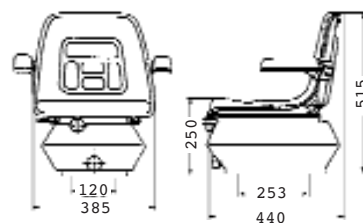

REF 106TA8604

Comfortable full suspension seat with runners. With weight adjustment.

(50-120 Kg), height adjustment (80mm), and front/rear adjustment.



This is a selection of seats & accessories. For all other seats & accessories, contact us.

ISRI 2300

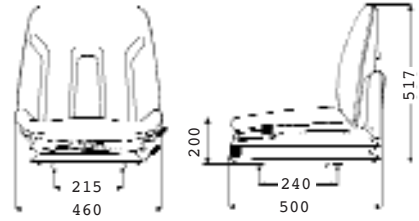

REF 106TA8607

Comfortable full suspension seat with runners. With weight and back rest adjustment (10°).

REF 110TA8860

Seat with retractable seat belt.

SEATS

ISRI 2300 NARROW

narrow

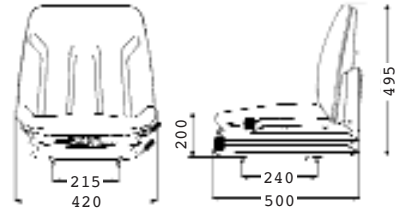

REF 106TA8605

Comfortable full suspension seat with runners. With weight and back rest adjustment (10°).

SUSPENSION SEAT

used on BT

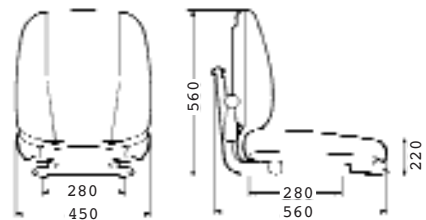

REF 106TA8606

Suspension seat with runners. Velour cover. Adjustable weight and cushion position. With safety switch.

VS 12

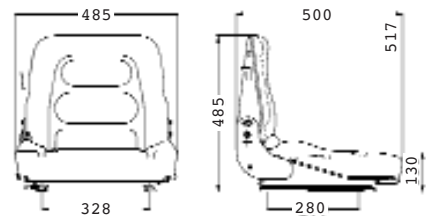

REF 106TA6738

Standard seat without belt.

REF 105TA4620

VS12 with retractable seat belt.

This is a selection of seats & accessories. For all other seats & accessories, contact us.

F 2000

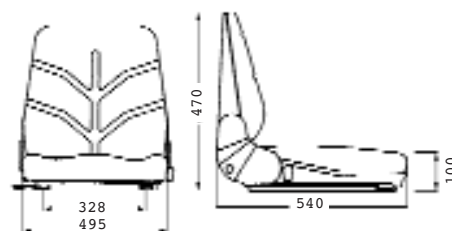

REF 105TA4617

Non suspension seat with runners. With foldable back, special for LPG trucks.

REF 110TA8779

Seat with retractable seat belt.

VS 85V

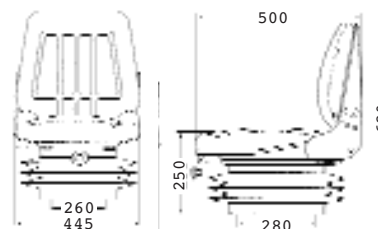

REF 105TA4616

Suspension seat with runners, weight adjustment (50-100 kg) and adjustable back (5-20°).

REF 110TA8789

Seat with retractable seat belt.

BUCKET FOLDABLE

gas application

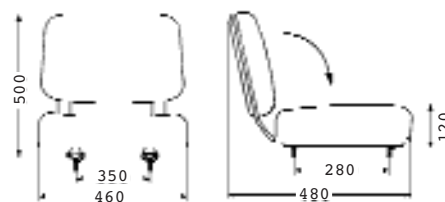

REF 106TA8608

Non suspension seat with slide rails and foldable backrest. For gas application.

UNIVERSAL SEAT

gas application

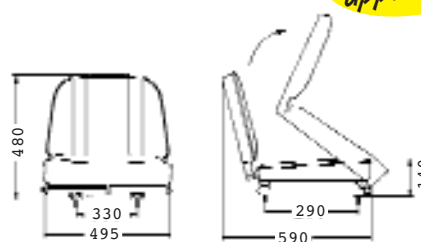

REF 106TA8609

Non suspension seat with slide rails. Fixed back rest and tilt forward function.



This is a selection of seats & accessories. For all other seats & accessories, contact us.

KAB 211

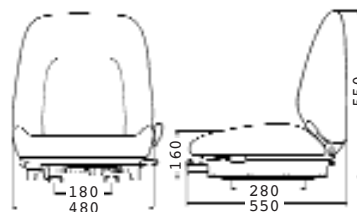

REF 106TA8610

Suspension seat with weight, cushion and back adjustment (complete with runners).

REF 110TA8879

Seat with retractable seat belt.

SEATS

DRIVER SEAT

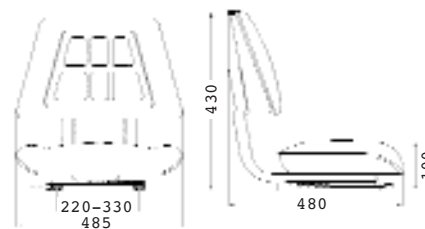

REF 105TA4618

Non suspension seat with slide rails.

REF 106TA8611

with switch

REF 110TA8814

Seat with retractable seat belt.

DRIVER SEAT

used on FIAT

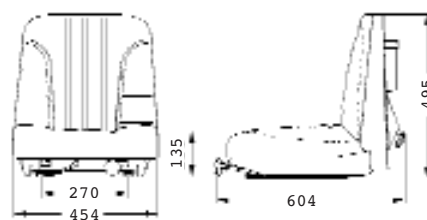

REF 106TA8612

Suspension seat with weight and backrest adjustment.

With document pouch.

ES 12

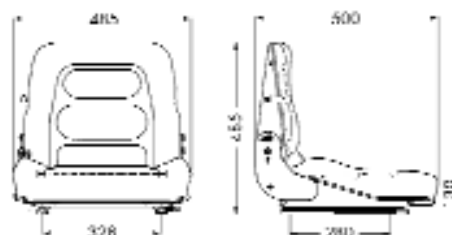

REF 119TA8975

Suspension seat with slide rails.

REF 119TA8976 (with switch)

REF 122TA7477

Seat with retractable seat belt.

This is a selection of seats & accessories. For all other seats & accessories, contact us.

VS 10 ECONOMY

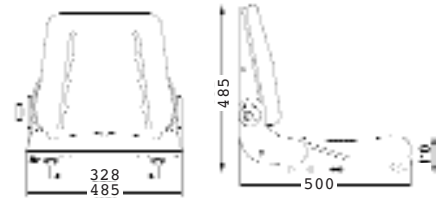

REF 106TA8615

Non suspension seat with slide rails.
With foldable backrest.

REF 106TA8616 With switch.

REF 110TA8782

Seat with retractable seat belt.

VS12 FOLDABLE SEAT

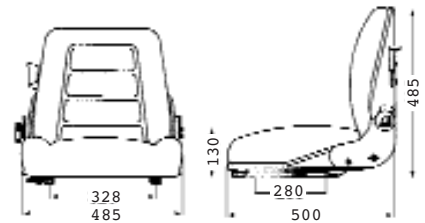

REF 106TA8622

VS 12 with foldable backrest.

UNIVERSAL SEAT

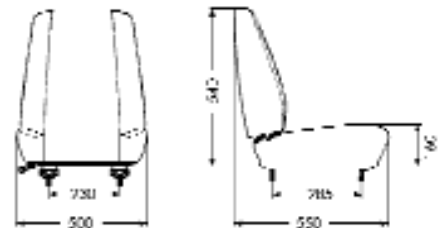

Non suspension seat with slide rails.

REF 110TA8989 - Standard version.

REF 110TA8991 - With retractable seat belt.

UNIVERSAL DRIVER SEAT

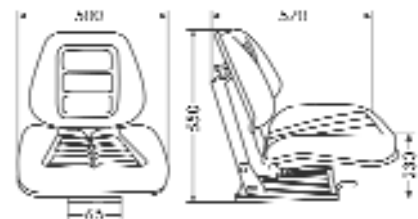

Suspension seat with weight adjustment and slide rails.

REF 111TA6584



SEAT BELT



REF 108TA8537

Automatic locking retractor.
Twin release buckle with rigid bracket.
EEC type approved (directive 77/541)
With bolt set.

SEAT BELT



REF 106TA5147

Automatic locking retractor.
Twin release buckle with rigid bracket.
EEC type approved (directive 77/541)
With bolt set.

SEAT BELT



REF 105TA4857

Automatic locking retractor.
Twin release buckle with webbing and PVC cover.
EEC type approved (directive 77/541)
With bolt set.

SEAT BELT



REF 106TA5148

Automatic locking retractor with webbing.
Release buckle with webbing.
EEC type approved (directive 77/541)
With bolt set.

SEAT BELT



REF 106TA5149

Automatic locking retractor.
Twin release buckle with spring webbing.
(special for suspension seats and YALE)
Complies to SAE J386.
With bolt set.

SEAT BELT



REF 106TA6748

With release knob. Complies to SAE J386
Webbing released when pushing the knob.

SEAT BELT



REF 105TA4859
 Static seat belt. Twin release buckle with rigid bracket.
 Adjustable webbing.
 EEC type approved (directive 77/541)
 With bolt set.

SEAT BELT



REF 106TA5150
 Static seat belt.
 Adjustable webbing.
 Release buckle with webbing.
 With bolt set.

SEAT BELT



REF 110TA8613
 Automatic locking retractor with electrically wired buckle.
 EEC type approved (directive 77/541)
 With bolt set.

SEAT BELT



REF 110TA8614
 Automatic locking retractor with 150 mm. extra webbing.
 EEC type approved (directive 77/541)
 With bolt set.

SEAT BELT



REF 110TA9012
 Dual sensitive seat belt.
 (retractor RH side)

SAFETY SWITCH

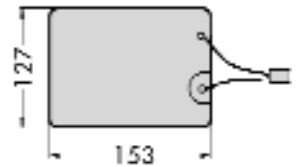

REF 106TA5151
 Universal micro switch.



SAFETY SWITCH

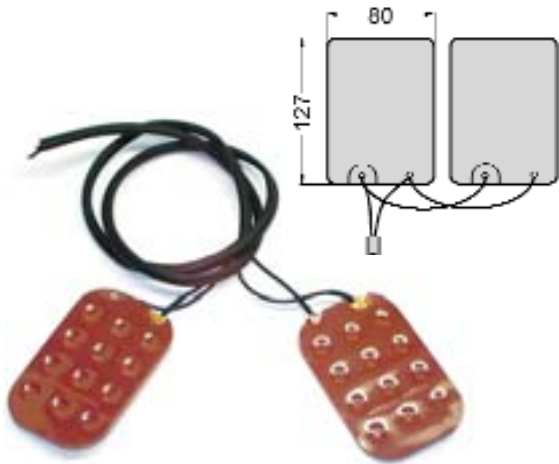

REF 106TA5153
Universal microswitch.

SAFETY SWITCH

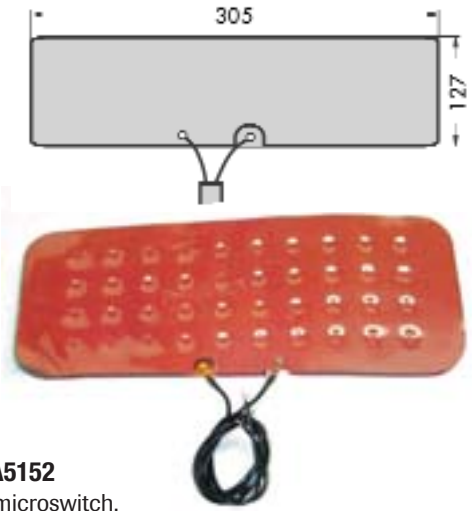

REF 106TA5152
Universal microswitch.

SAFETY SWITCH



REF 110TA9013
Used on DAEWOO seats.

SAFETY SWITCH



REF 110TA8647
Used on GRAMMER MSG 20.

SAFETY SWITCH



REF 110TA9014
Used on HYSTER.

SAFETY SWITCH



REF 110TA9015
Used on LINDE.

SAFETY SWITCH



REF 110TA9016
Used on STILL.

SAFETY SWITCH



REF 110TA8658
Used on ISRI seats.

SEAT BELT BRACKET



REF 105TA4861
Allows easy fitting of the belt to the seat-slides.
(ex. MSG 20)
Kit of 2 brackets.

UNIVERSAL SEAT BELT BRACKET

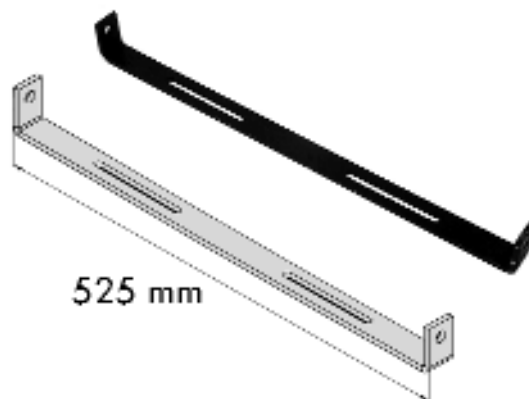

REF 106TA5154
Easy to fit between seat and slides.
One size fits all (max. width 50 cm).

RUNNER SET



REF 106TA8624
Slide rails 356 mm.
Used on Grammer DS 85/90.

UNIVERSAL RUNNER SET



REF 106TA8625
Universal runner set.

HIP RESTRAINTS



REF 110TA8770
Used on VS12.

SHOULDER RESTRAINT



REF 110TA9017
Used on MSG 20 seats.

ARMREST KIT



REF 110TA8769
Used on VS12.

ARMREST KIT



REF 110TA8871
Used on ISRI seats.

ARMREST KIT



REF 110TA8937
Used on KAB seats.

ARMREST KIT



REF 110TA8831
Used on KLEPP seats.



SEAT ACCESSORIES

SEAT CUSHIONS

This is only a selection of the seat cushions in our program. Please contact us for more information.

REF 106TA8626
Used on Lansing.



REF 106TA8627
Seat cushion PVC, used on DS 85/90.



REF 106TA8628
Seat cushion PVC, used on MSG20.



REF 106TA8629
Back cushion PVC, used on DS 85/90.



REF 106TA8630
Back cushion PVC, used on GS 12/VS 12.



REF 107TA5258
Seat cushion PVC, used on GS 12/VS 12.



REF 110TA8621
Seat cushion PVC, used on MSG85721.



REF 110TA8622
Seat cushion PVC, used on ISRI 2300 series.





SEAT HEATING



For KAB and BEGE seats.
To fit in seat and back cushion.
With thermostat.

- REF 106TA8617 - 12 V
- REF 106TA8618 - 24 V
- REF 106TA8619 - 48 V

SEAT HEATING



OPTIONAL
REF 115TA1802
- Adaptor cigarette lighter
- 2 exits

To fit on top of seat cushions with thermostat. The heat cushion contains two connected elements, back and seat element. A temperature regulator in the current circuit of the seat element is energized at $20 \pm 3,3$ degrees C (68 ± 6 degrees F) and opens at $28,3 \pm 2,8$ degrees C (83 ± 5 degrees F).

- REF 106TA8620 - 12 V
- REF 106TA8621 - 24 V

WATERPROOF SEAT COVER



Specially designed for truck-mounted trucks and for all vehicles that are parked outside.

REF 106TA6749
With openings for head rest and documents.

SUMMER SEAT COVER



REF 106TA8623
To fit on top of seat and back cushions.
Comfortable driving on hot summer days.

PLASTIC DOCUMENT HOLDER



REF 107TA7951
Universal document holder.

PLASTIC DOCUMENT HOLDER



REF 107TA7952
Used on GRAMMER GS12.

DOCUMENT HOLDER

*For all document holders see
chapter CABS & CAB PARTS*



REF 106TA8631
Universal document holder.

STICKER



REF 107TA7976
Sticker seat belt