

NEW

These trucks and trolleys, manufactured in Scandinavia, are of outstanding quality: they are extremely light and versatile. With over 500 models, these trolleys are used in warehouses, offices, hospitals, hotels, airports etc.

There is a suitable truck or trolley for every application: for transporting light or heavy loads, transport over long distances, ESD-proof trolleys, bin trolleys, post trolleys and even scooters! Both design and service life are important to the manufacturer when finishing these trucks and trolleys: the frames have a gloss galvanized finish, the shelves are laminated (unless specified otherwise). **Consequently we can offer a lifetime guarantee on all ergonomic trucks and trolleys!**

Table trolley with 5 or 6 wheels

**Extremely versatile:
ideal for small spaces!**

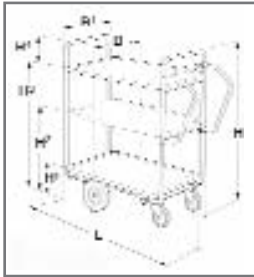

- ✓ Small trolleys: 3 castors
Large trolleys: 4 castors
- ✓ Top shelves are removable
- ✓ Load capacity: 300 kg
Per shelf: 150 kg
- ✓ Rigid castors: 200 x 50 mm
- ✓ Castors: 125 x 32 mm

REF	Shelf	L	W	W1	H	H1	H2	H3	H4
2 shelves									
119TA9288	850x520	1130	540	460	1110	225	---	765	120
119TA9294	850x620	1130	620	460	1110	225	---	765	120
109TA9300	1250x620	1530	620	460	1110	225	---	765	120
3 shelves									
119TA9290	850x520	1130	540	460	1110	225	620	960	160
119TA9296	850x620	1130	620	460	1110	225	620	960	160
119TA9302	1250x620	1530	620	460	1110	225	620	960	160

Table trolley with step - 5 or 6 wheels

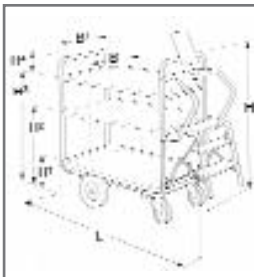

- ✓ Small trolleys: 3 castors
Large trolleys: 4 castors
- ✓ Top shelves are removable
- ✓ Load capacity: 300 kg - Per shelf: 150 kg
- ✓ Rigid castors: 200 x 50 mm
- ✓ Castors: 125 x 32 mm
- ✓ Step folds automatically
Top step 600 mm
- ✓ Clipboard and pen tray included!

REF	Shelf	L	W	W1	H	H1	H2	H3	H4
2 shelves									
119TA9304	850x520	1130	540	460	1110	225	---	765	120
119TA9308	850x620	1130	620	460	1110	225	---	765	120
119TA9312	1250x620	1530	620	460	1110	225	---	765	120
3 shelves									
119TA9306	850x520	1130	540	460	1110	225	620	960	160
119TA9310	850x620	1130	620	460	1110	225	620	960	160
119TA9314	1250x620	1530	620	460	1110	225	620	960	160

**Extremely versatile:
ideal for small spaces!**

* all dimensions are given in millimetres

Extremely versatile trucks and trolleys!

✓ **Ideal for small spaces!**

Platform trolley with 5 or 6 wheels



- ✓ Small trolleys: 3 castors
Large trolleys: 4 castors
- ✓ Load capacity: 300 kg
- ✓ Choice of handle: horizontal or vertical
- ✓ Rigid castors: 200 x 50 mm
- ✓ Castors: 125 x 32 mm

REF	Shelf	L	W	H	H1
2 shelves (horizontal handle)					
119TA9316	850x520	960	460	950	225
119TA9318	850x620	960	460	950	225
119TA9320	1250x620	1350	460	950	225
3 shelves (vertical handle)					
119TA9286	850x520	1130	460	1110	225
119TA9292	850x620	1130	460	1110	225
119TA9298	1250x620	1530	460	1110	225

Table trolley without handle

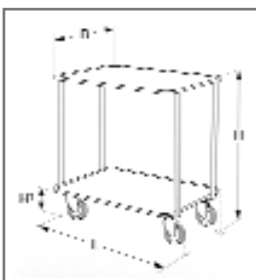

- ✓ Choice of wheels:
Rubber for light loads (200 kg)
Nylon for heavier loads (400 kg)
- ✓ Adjustable height!

REF	Shelf	L	W	H	H1
Rubber wheels					
119TA9334	850x620	850	620	900	225
Nylon wheels					
119TA9336	850x620	850	620	900	225

* all dimensions are given in millimetres

✓ *Accessories for trucks and trolleys that perfectly meet the customer's requirements!*

Accessories for trucks and trolleys available



Load support grid
Mesh size 100 x 50 mm



Basket
150 x 330 x 180 mm



Rack with pen tray
310 x 80 mm

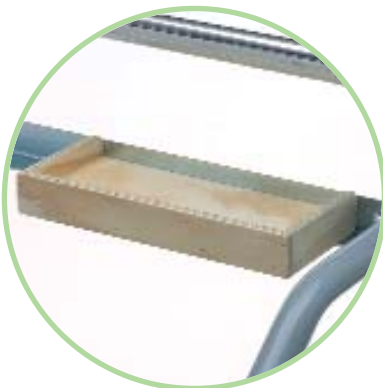

Pen tray
180 x 80 mm



Clipboard
A4 size available
horizontal or vertical
mounting



Elastic wheel with ball bearing
Very quiet and soft
Non-marking grey
200 x 46 mm



Nylon wheel with ball bearing
With polyurethane cover
Low rolling resistance
200 x 46 mm

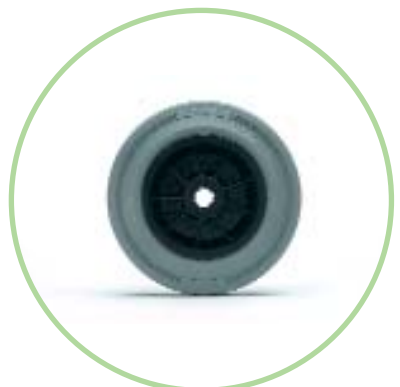

Wheel with roller bearing
For delicate surfaces
Non-marking grey
200 x 50 mm

- ✓ *Flexible ergonomic trolleys:
2 adjustable shelves and handle!*
- ✓ *4 castors 125 x 32 mm (non-marking rubber)*

Table trolley with 2 mesh end grids



- ✓ Height-adjustable and reversible shelves!
- ✓ Laminate finish: long service life!
- ✓ Load capacity 200 kg
100 kg on top shelf
- ✓ Mesh size: 100 x 50 mm

REF	Shelf	L	W	H	H1 _{min}	H2 _{max}	H3
2 shelves							
119TA9401	620x425	800	460	1120	270	800	895
119TA9407	750x425	930	460	1120	270	800	895
119TA9413	1000x425	1180	460	1120	270	800	895
119TA9419	1200x425	1380	460	1120	270	800	895
3 shelves							
119TA9403	620x425	800	460	1120	270	1050	1120
119TA9409	750x425	930	460	1120	270	1050	1120
119TA9415	1000x425	1180	460	1120	270	1050	1120
119TA9421	1200x425	1380	460	1120	270	1050	1120
4 shelves							
119TA9405	620x425	800	460	1585	270	1500	1585
119TA9411	750x425	930	460	1585	270	1500	1585
119TA9417	1000x425	1180	460	1585	270	1500	1585
119TA9423	1200x425	1380	460	1585	270	1500	1585

Wide range of accessories available

Table trolley with 2 mesh end grids and mesh shelves

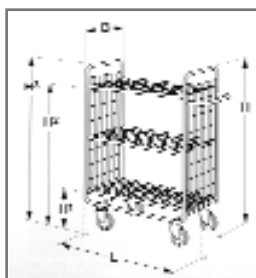

- ✓ Shelves are height-adjustable!
- ✓ Load capacity 200 kg
100 kg on top shelf

REF	Shelf	L	W	H	H1 _{min}	H2 _{max}	H3
2 shelves							
119TA9465	750x450	930	460	1120	270	800	895
119TA9471	1000x450	1180	460	1120	270	800	895
119TA9477	1200x450	1380	460	1120	270	800	895
3 shelves							
119TA9467	750x450	930	460	1120	270	1050	1120
119TA9473	1000x450	1180	460	1120	270	1050	1120
119TA9479	1200x450	1380	460	1120	270	1050	1120
4 shelves							
119TA9469	750x450	930	460	1585	270	1500	1585
119TA9475	1000x450	1180	460	1585	270	1500	1585
119TA9481	1200x450	1380	460	1585	270	1500	1585

* all dimensions are given in millimetres

- ✓ *Equipped with 4 grey rubber castors
125 x 32 mm (non-marking)*

Table trolley with 2 mesh end grids and steps



- ✓ Load capacity: 200 kg
Top shelf: 100 kg
- ✓ Supplied with clipboard and pen tray
- ✓ Supplied with steps (600 mm)!
- ✓ Laminate finish: long service life!
- ✓ Height-adjustable and reversible shelves!

REF	Shelf	L	W	H	H1min	H2max	H3
2 shelves							
119TA9425	620x425	890	460	1120	270	800	895
119TA9431	750x425	1020	460	1120	270	800	895
119TA9437	1000x425	1270	460	1120	270	800	895
3 shelves							
119TA9427	620x425	890	460	1120	270	1050	1120
119TA9433	750x425	1020	460	1120	270	1050	1120
119TA9439	1000x425	1270	460	1120	270	1050	1120
4 shelves							
119TA9429	620x425	890	460	1585	270	1500	1585
119TA9435	750x425	1020	460	1585	270	1500	1585
119TA9441	1000x425	1270	460	1585	270	1500	1585

Platform trolley with 4 mesh grids

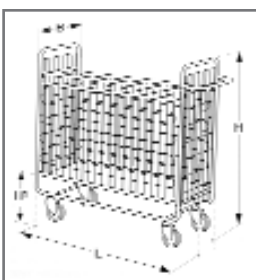

- ✓ Laminate finish: long service life!
- ✓ Removable side grids
- ✓ Load capacity: 200 kg

REF	L	W	H	H1min
119TA9483	800	460	1120	270
119TA9485	930	460	1120	270
119TA9487	1180	460	1120	270
119TA9489	1380	460	1120	270

* all dimensions are given in millimetres

- ✓ Equipped with 4 grey rubber castors
125 x 32 mm (non-marking)

Platform trolley

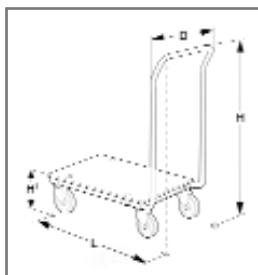

- ✓ Laminate finish: long service life!
- ✓ Load capacity: 200 kg

REF	Shelf	L	W	H	H1
1 shelf					
119TA9180	530x465	670	465	960	210
119TA9188	660x465	800	465	960	210
119TA9196	910x465	1050	465	960	210

Table trolley

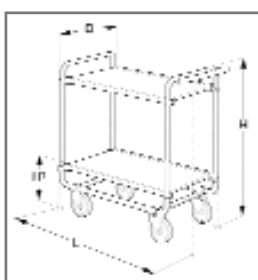

- ✓ Adjustable shelves
- ✓ Laminate finish on shelves (on top and underneath)
- ✓ Load capacity: 150 kg
Top shelf: 100 kg

REF	Shelf	L	W	H	H1min
2 shelves					
119TA9262	750x425	900	460	890	270
119TA9264	1000x425	1150	460	890	270

* all dimensions are given in millimetres

Accessories for trucks and trolleys available

✓ *Accessories for trucks and trolleys that perfectly meet the customer's requirements!*

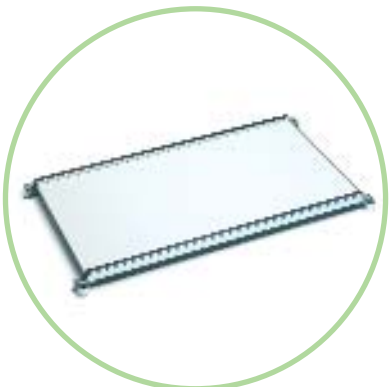

Extra shelf
Width: 425 mm
Various lengths available



Clipboard
A4 size available
horizontal or vertical mounting

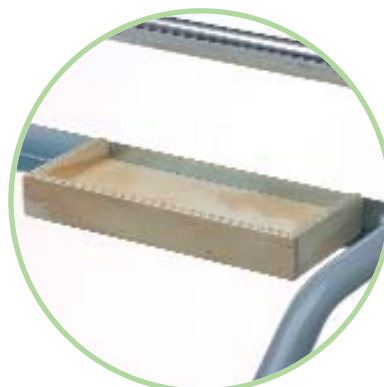

Pen tray
180 x 80 mm



Rack with pen tray
310 x 80 mm



Mesh shelf
Mesh size: 24 x 100 mm
Various sizes available



Mesh side grid
Mesh size: 65 x 50 mm
Various sizes available



Low mesh grid
Mesh size: 30 x 30 mm
Height: 161 mm



Basket
150 x 330 x 180 mm



Dividers
For fitting on the shelf
275 x 250 mm / 365 x 250 mm

- ✓ *Lightweight ergonomic trolleys for long distances!*
- ✓ *Very stable: 2 fixed wheels and 2 castors (160 x 40 mm)*

Shelf trolley with mesh end grids

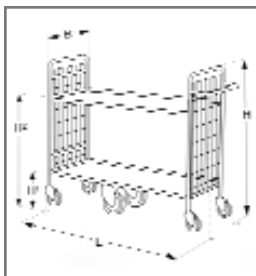

- ✓ Laminate finish on shelves (on top and underneath)
- ✓ Load capacity: 300 kg
Top shelf: 100 kg
- ✓ Wheels: black rubber
- ✓ Mesh: 65 x 50 mm

REF	Shelf	L	W	H	H1	H2max
2 shelves						
119TA9715	800x600	990	650	1030	245	960
119TA9717	1000x600	1190	650	1030	245	960
119TA9719	1200x600	1390	650	1030	245	960
119TA9721	1400x600	1590	650	1030	245	960
119TA9723	1600x600	1790	650	1030	245	960
4 shelves						
119TA9725	800x600	990	650	1690	245	1670
119TA9727	1000x600	1190	650	1690	245	1670
119TA8986	1200x600	1390	650	1690	245	1670
119TA8988	1400x600	1590	650	1690	245	1670
119TA8990	1600x600	1790	650	1690	245	1670

Shelf trolley with mesh end grids - 6 wheels

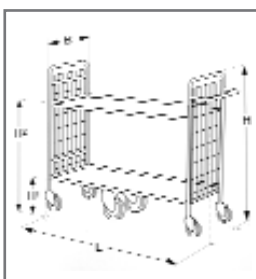

- ✓ 4 castors 125 x 32 mm
2 support wheels 250 x 50 mm
- ✓ Grey, non-marking rubber wheels
- ✓ Laminate finish on shelves (on top and underneath)
- ✓ Load capacity: 300 kg
Top shelf: 100 kg

REF	Shelf	L	W	H	H1	H2max
2 shelves						
119TA9701	1000x425	1180	460	1120	280	1050
119TA9703	1200x425	1380	460	1120	280	1050
119TA9705	1400x425	1580	460	1120	280	1050
119TA9707	1600x425	1780	460	1120	280	1050
4 shelves						
119TA9709	1200x425	1380	460	1650	280	1630
119TA9711	1400x425	1580	460	1650	280	1630
119TA9713	1600x425	1780	460	1650	280	1630

* all dimensions are given in millimetres

Platform trolley with mesh end grid

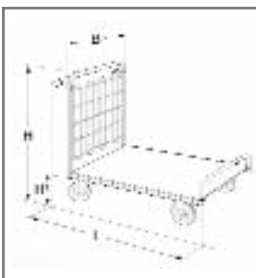

- ✓ Laminate finish on shelf
- ✓ Load capacity: 300 kg
- ✓ With low bracket: goods do not fall off the trolley
- ✓ Lightweight platform trolley for transporting of large boxes and stackable goods

Trolleys for long distances!

REF	Shelf	L	W	H	H1
1 shelf					
119TA9616	800x600	990	650	1030	245
119TA9618	1000x600	1190	650	1030	245
119TA9620	1200x600	1390	650	1030	245
119TA9622	1400x600	1590	650	1030	245
119TA9624	1600x600	1790	650	1030	245

Platform trolley with 4 mesh grids

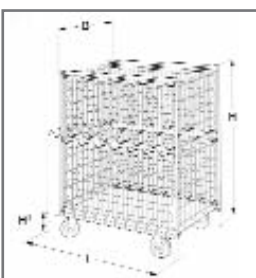

- ✓ Removable side grids
- ✓ Choice: low or high grids
- ✓ Ideal for transporting small parcels
- ✓ Load capacity: 400 kg

Trolleys for long distances!

REF	Shelf	L	W	H	H1
Low grids					
119TA9136	800x600	990	650	1030	245
119TA9138	1000x600	1190	650	1030	245
119TA9140	1200x600	1390	650	1030	245
119TA9142	1400x600	1590	650	1030	245
119TA9144	1600x600	1790	650	1030	245
High grids					
119TA9146	800x600	990	650	1690	245
119TA9148	1000x600	1160	650	1690	245
119TA9150	1200x600	1390	650	1690	245
119TA9152	1400x600	1590	650	1690	245
119TA9154	1600x600	1790	650	1690	245

* all dimensions are given in millimetres

Accessories for trucks and trolleys available



Basket
150 x 330 x 180 mm



Clipboard
A4 size available
horizontal or vertical mounting



Mesh side grid
Mesh size: 65 x 50 mm
Various sizes available



Extra shelf
Width: 425 mm
Various lengths available



Fork guides
For taking trucks and trolleys along the side



Low mesh grid
Mesh size: 30 x 30 mm
Height: 161 mm



Dividers
For fitting on the shelf
275 x 250 mm / 365 x 250 mm

✓ *Accessories for trucks and trolleys that perfectly meet the customer's requirements!*



Protective strip
Steel covered with rubber
Height: 33 mm
Width: 25 mm



Folding steps with handle
Top step: 600 mm



Grey non-marking wheel
For delicate surfaces
200 x 50 mm



Dual brake castor
160 x 40 mm



Pneumatic tyre with roller bearings
Ideal for uneven surfaces
210 x 65 mm



Support wheels
2 rigid castors in the centre &
2 castors at the ends:
excellent stability
For trolleys size
1200 x 600 mm and longer



Nylon wheel with ball bearing
With polyurethane cover
Low rolling resistance
200 x 46 mm



Elastic wheel with ball bearing
Very quiet and soft
Non-marking grey rubber
200 x 46 mm

Accessories for trucks and trolleys available

- ✓ *Ergonomic trolleys for heavy loads up to 500 kg*
- ✓ *With reinforced shelves and chassis*
- ✓ *Equipped with 2 fixed wheels and 2 castors*
- ✓ *Wheels black rubber: 200 x 50 mm*

Shelf trolley for heavy loads



- ✓ Height-adjustable shelves
- ✓ Laminate finish on shelves (on top and underneath)
- ✓ Load capacity: 500 kg
Top shelves: 150 kg

REF	Shelf	L	W	H	H1	H2max
2 shelves						
119TA8992	800x520	1000	570	1180	285	1000
119TA8996	1000x520	1200	570	1180	285	1000
119TA9002	1200x520	1400	570	1180	285	1000
119TA8994	800x600	1000	650	1180	285	1000
119TA8998	1000x600	1200	650	1180	285	1000
119TA9004	1200x600	1400	650	1180	285	1000
119TA9010	1400x600	1600	650	1180	285	1000
119TA9016	1600x600	1800	650	1180	285	1000
119TA9000	1000x700	1200	750	1180	285	1000
119TA9006	1200x700	1400	750	1180	285	1000
119TA9012	1400x700	1600	750	1180	285	1000
119TA9018	1600x700	1800	750	1180	285	1000
119TA9008	1200x800	1400	850	1180	285	1000
119TA9014	1400x800	1600	850	1180	285	1000
119TA9020	1600x800	1800	850	1180	285	1000
3 shelves						
119TA9022	800x520	1000	570	1860	285	1700
119TA9026	1000x520	1200	570	1860	285	1700
119TA9032	1200x520	1400	570	1860	285	1700
119TA9024	800x600	1000	650	1860	285	1700
119TA9028	1000x600	1200	650	1860	285	1700
119TA9034	1200x600	1400	650	1860	285	1700
119TA9040	1400x600	1600	650	1860	285	1700
119TA9048	1600x600	1800	650	1860	285	1700
119TA9030	1000x700	1200	750	1860	285	1700
119TA9036	1200x700	1400	750	1860	285	1700
119TA9042	1400x700	1600	750	1860	285	1700
119TA9050	1600x700	1800	750	1860	285	1700
119TA9038	1200x800	1400	850	1860	285	1700
119TA9044	1400x800	1600	850	1860	285	1700
119TA9052	1600x800	1800	850	1860	285	1700

* all dimensions are given in millimetres

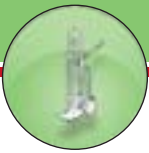

Trolleys for heavy loads!

TRUCKS AND TROLLEYS - ERGONOMIC

Platform trolley with tubular frame-ends



- ✓ Load capacity 500 kg
- ✓ Available with 1 or 2 frame-ends
- ✓ Trolley with 1 frame-end has 1 support rim to prevent the load from falling off

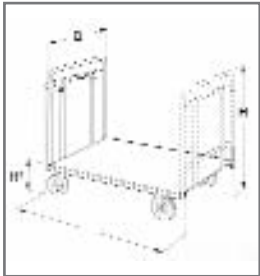

REF	Shelf	L	W	H	H1
1 frame-end - 1 low support rim					
119TA9064	800x520	1000	570	1180	285
119TA9068	1000x520	1200	570	1180	285
119TA9076	1200x520	1400	570	1180	285
119TA9066	800x600	1000	650	1180	285
119TA9070	1000x600	1200	650	1180	285
119TA9078	1200x600	1400	650	1180	285
119TA9084	1400x600	1600	650	1180	285
119TA9090	1600x600	1800	650	1180	285
119TA9072	1000x700	1200	750	1180	285
119TA9080	1200x700	1400	750	1180	285
119TA9086	1400x700	1600	750	1180	285
119TA9092	1600x700	1800	750	1180	285
119TA9096	2000x700	2200	750	1180	285
119TA9074	1000x800	1200	850	1180	285
119TA9082	1200x800	1400	850	1180	285
119TA9088	1400x800	1600	850	1180	285
119TA9094	1600x800	1800	850	1180	285
119TA9098	2000x800	2200	850	1180	285
2 frame-ends					
119TA9100	800x520	1000	570	1180	285
119TA9104	1000x520	1200	570	1180	285
119TA9112	1200x520	1400	570	1180	285
119TA9102	800x600	1000	650	1180	285
119TA9106	1000x600	1200	650	1180	285
119TA9114	1200x600	1400	650	1180	285
119TA9120	1400x600	1600	650	1180	285
119TA9126	1600x600	1800	650	1180	285
119TA9108	1000x700	1200	750	1180	285
119TA9116	1200x700	1400	750	1180	285
119TA9122	1400x700	1600	750	1180	285
119TA9128	1600x700	1800	750	1180	285
119TA9132	2000x700	2200	750	1180	285
119TA9110	1000x800	1200	850	1180	285
119TA9118	1200x800	1400	850	1180	285
119TA9124	1400x800	1600	850	1180	285
119TA9130	1600x800	1800	850	1180	285
119TA9134	2000x800	2200	850	1180	285

Platform trolley with 4 tubular frames



- ✓ Load capacity 500 kg
- ✓ side-frames fold open
- ✓ Ideal for transporting parcels

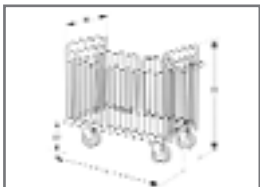

REF	Shelf	L	W	H	H1min
119TA9156	1000x600	1200	650	1180	285
119TA9160	1200x600	1400	650	1180	285
119TA9166	1400x600	1600	650	1180	285
119TA9172	1600x600	1800	650	1180	285
119TA9158	1000x700	1200	750	1180	285
119TA9162	1200x700	1400	750	1180	285
119TA9168	1400x700	1600	750	1180	285
119TA9174	1600x700	1800	750	1180	285
119TA9164	1200x800	1400	850	1180	285
119TA9170	1400x800	1600	850	1180	285
119TA9176	1600x800	1800	850	1180	285

* all dimensions are given in millimetres

Accessories for trucks and trolleys available



Clipboard
A4 size available
horizontal or vertical
mounting



Tow rod
For linking trolleys together
Length: 470 mm Eye: Ø 23 mm



Tow hook
Hook diameter: 22 mm
With lock



Dividers
For fitting on the shelf
275 x 250 mm / 365 x 250 mm



Fork guides
For taking trucks and
trolleys along the side



Mesh side grid
Mesh size: 65 x 50 mm
Various sizes available

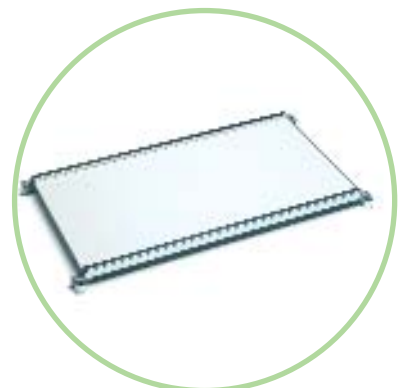

Extra shelf
Width: 425 mm
Various lengths available



Low mesh grid
Mesh size: 30 x 30 mm
Height: 161 mm



Rack with pen tray
310 x 80 mm

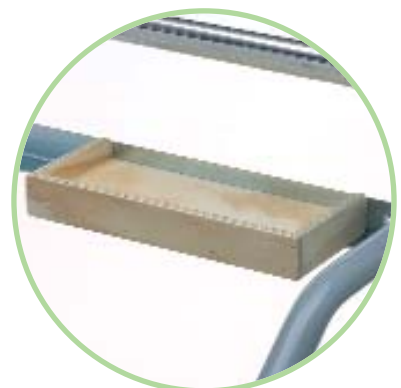

Pen tray
180 x 80 mm



Accessories for trucks and trolleys available



Protective strip
Steel covered with rubber
Height: 33 mm
Width: 25 mm



Folding steps with handle
Top step: 600 mm



Tubular frame-ends
Thickness: 7 mm - Spacing: 75 mm
for high frame-ends 2 are required on each end



Support wheels
2 rigid castors in the centre & 2 castors at the ends: excellent stability
For trolleys size 1200 x 600 mm and longer



Pneumatic tyre with roller bearings
Ideal for uneven surfaces
210 x 65 mm



Grey non-marking wheel
For delicate surfaces
200 x 50 mm



Dual brake castor
160 x 40 mm



Nylon wheel with ball bearing
With polyurethane cover
Low rolling resistance
200 x 46 mm



Elastic wheel with ball bearing
Very quiet and soft
Non-marking grey
200 x 46 mm

- ✓ *Ergonomic platform trolleys for boxes!*
- ✓ *4 castors 125 x 32 mm*

Shelf trolley for Euronorm boxes



- ✓ Load capacity: 200 kg
- ✓ Space for 8 Euronorm boxes
600 x 400 mm

REF	L	W	H	H1
119TA9499	670	465	1585	260

Accessories:

119TA9173 Dual brakes for 2 wheels

119TA9187 Direction can be locked for one wheel

- ✓ *Rails are height-adjustable!*
- ✓ *Boxes can be fitted on a slope!*

Shelf trolley with adjustable rails (for Euronorm boxes)



- ✓ Boxes can be replaced by shelves
- ✓ Load capacity: 200 kg
- ✓ For 600 x 400 mm boxes
- ✓ Rails and shelves not included

REF	L	W	H	H1
119TA9497	670	463	1785	165
2 rails				
119TA9277	n/a	n/a	n/a	n/a
2 rails with stop pin				
119TA9279	n/a	n/a	n/a	n/a

Accessories:

119TA9281 Shelf

119TA9173 Dual brakes for 2 wheels

* all dimensions are given in millimetres

**Trolleys
for Euronorm boxes!**

Dolly and pallet dolly

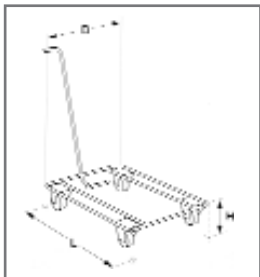

Accessories:

- 119TA9125 Push rod dolly small
- 119TA9127 Push rod dolly large

- ✓ Nylon or polyurethane wheels with slide bearings - 100 x 35 mm
- ✓ Dolly: 400 kg load capacity
- ✓ Pallet dolly for half or full Euro pallets: 500 kg load capacity

REF	Shelf	L	W	H	Wheel type
Large dolly					
119TA9577	800x600	852	606	155	Nylon 2 castors/2 rigid castors
119TA9575	800x600	852	606	155	Nylon 4 castors
119TA9585	800x600	852	606	155	Polyurethane 2 castors/2 rigid castors
119TA9583	800x600	852	606	155	Polyurethane 4 castors
Small dolly					
119TA9573	600x400	652	410	155	Nylon 2 castors/2 rigid castors
119TA9571	600x400	652	410	155	Nylon 4 castors
119TA9581	600x400	652	410	155	Polyurethane 2 castors/2 rigid castors
119TA9579	600x400	652	410	155	Polyurethane 4 castors
Pallet dolly: Euro pallet					
119TA9609	1 pallet	1042	815	140	Nylon 2 castors/2 rigid castors
119TA9607	1 pallet	1042	815	140	Nylon 4 castors
119TA9617	1 pallet	1042	815	140	Polyurethane 2 castors/2 rigid castors
119TA9615	1 pallet	1042	815	140	Polyurethane 4 castors
Pallet dolly: half pallet					
119TA9605	Half pallet	815	575	140	Nylon 2 castors/2 rigid castors
119TA9603	Half pallet	815	575	140	Nylon 4 castors
119TA9613	Half pallet	815	575	140	Polyurethane 2 castors/2 rigid castors
119TA9611	Half pallet	815	575	140	Polyurethane 4 castors

Dolly - trolley



- ✓ Nylon castors with slide bearings 100 x 35 mm (ESD wheels with ball bearings 125 x 32 mm)
- ✓ Supplied with 10 dollies (ESD model with 8 dollies)

REF	Description	Wheel type	L	W	H
119TA9346	Trolley	Nylon 4 castors	709	464	1750
119TA9595	Trolley with dollies	Nylon 4 castors	709	464	1750
119TA9597	Trolley with dollies	Nylon 2 castors/ 2 fixed	709	464	1750
119TA9599	Trolley with dollies	Polyurethane 4 castors	709	464	1750
119TA9601	Trolley with dollies	Pol. 2 castors/2 fixed	709	464	1750
119TA9748	ESD trolley	ESD 4 castors	709	464	1770
119TA9749	ESD trolley - dollies	ESD 4 castors	709	464	1770

* all dimensions are given in millimetres

Collection trolley



- ✓ 4 castors 125 x 32 mm
- ✓ For plastic Euronorm boxes, 600 x 400 mm
- ✓ 2 top levels can be fitted on a slant at 10, 20 or 30°
- ✓ Shelf load capacity: 100 kg
- ✓ Shelves are optional

REF	Dimensions (mm)	L	W	H	H1
119TA9495	600x400	740	430	1165	195

Accessories:
119TA9281 Shelf

Raised dolly

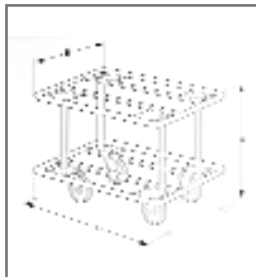

- ✓ 4 nylon castors 100 x 35 mm
- ✓ Small model: 500 x 400 mm boxes
- ✓ Large model: 800 x 600 mm boxes
- ✓ Load capacity: 300 kg

Ideal height for comfortable lifting!

REF	L	W	H	Model
119TA9338	655	410	460	Small
119TA9340	855	605	460	Large

* all dimensions are given in millimetres

ESD-proof trucks and trolleys!

Dolly with handle

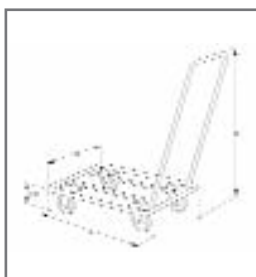

- ✓ 2 rigid castors and 2 castors 100 x 35 mm
- ✓ Suitable for 600 x 400 mm boxes
- ✓ Handle can be fitted on each side
- ✓ Load capacity: 300 kg

REF	L	W	H	H1min	Wheels
119TA9342	750	410	940	145	Nylon
119TA9344	750	410	940	145	Polyurethane

Choice of nylon or polyurethane wheels!

Ideal height for comfortable lifting!

Raised dolly with handle



- ✓ 4 castors: 125 x 32 mm
- ✓ Suitable for 600 x 400 mm boxes
- ✓ Maximum height of shelf 460 mm
- ✓ Load capacity: 100 kg
- ✓ Extra box can be put on the chassis

REF	Dimensions (mm)	L	W	H	H1
119TA9178	620x425	760	460	960	460

Accessories:
119TA9173 Dual brake

* all dimensions are given in millimetres

✓ ESD-proof trolleys prevent static electricity discharge

ESD-proof table trolley



Accessories:

REF	Description
119TA9179	ESD-proof brake



- ✓ 4 castors with roller bearings 125 x 32 mm
- ✓ Shelves and wheels in conductive materials
- ✓ Height adjustable
- ✓ Load capacity 200 kg
100 kg on top shelf

REF	Shelf	L	W	H	H1min	H2max	H3
2 shelves							
119TA9720	620x430	800	460	1120	335	800	895
119TA9726	750x430	930	460	1120	335	800	895
119TA9730	1000x430	1180	460	1120	335	800	895
119TA9733	1200x430	1380	460	1120	335	800	895
3 shelves							
119TA9722	620x430	800	460	1120	335	1010	1120
119TA9728	750x430	930	460	1120	335	1010	1120
119TA9731	1000x430	1180	460	1120	335	1010	1120
119TA9734	1200x430	1380	460	1120	335	1010	1120
4 shelves							
119TA9724	620x430	800	460	1585	335	1480	1585
119TA9729	750x430	930	460	1585	335	1480	1585
119TA9732	1000x430	1180	460	1585	335	1480	1585
119TA9735	1200x430	1380	460	1585	335	1480	1585

ESD-proof shelf trolley with mesh ends grids



Accessories:

REF	Description
119TA9179	ESD-proof brake



- ✓ 2 rigid castors and 2 castors with roller bearings 200 x 50 mm
- ✓ Height-adjustable handle and shelves
- ✓ Load capacity: 300 kg
Top shelf 100 kg

REF	Shelf	L	W	H	H1min	H2max
2 shelves - low model						
119TA9754	800x620	990	650	1070	245	1000
119TA9755	1000x620	1190	650	1070	245	1000
119TA9756	1200x620	1390	650	1070	245	1000
119TA9757	1400x620	1590	650	1070	245	1000
119TA9758	1600x620	1790	650	1070	245	1000
4 shelves - high model						
119TA9759	800x620	990	650	1730	245	1710
119TA9760	1000x620	1190	650	1730	245	1710
119TA9761	1200x620	1390	650	1730	245	1710
119TA9762	1400x620	1590	650	1730	245	1710
119TA9763	1600x620	1790	650	1730	245	1710

* all dimensions are given in millimetres

**ESD-proof
trucks and trolleys!**

- ✓ *Shelves in conductive materials!*
- ✓ *Shelves and handle are height-adjustable!*

ESD-proof shelf trolley with tubular frame-ends

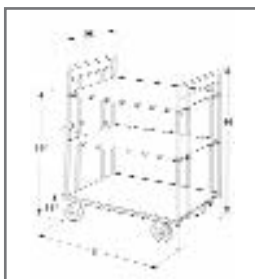

- ✓ 2 rigid castors and 2 castors 200 x 50 mm
- ✓ Load capacity: 500 kg
Top shelves: 150 kg

REF	Shelf	L	W	H	H1	H2max
2 shelves: low model						
119TA9764	800x520	1000	570	1180	285	1000
119TA9766	1000x520	1200	570	1180	285	1000
119TA9769	1200x520	1400	570	1180	285	1000
119TA9765	800x600	1000	650	1180	285	1000
119TA9767	1000x600	1200	650	1180	285	1000
119TA9770	1200x600	1400	650	1180	285	1000
119TA9773	1400x600	1600	650	1180	285	1000
119TA9776	1600x600	1800	650	1180	285	1000
119TA9768	1000x700	1200	750	1180	285	1000
119TA9771	1200x700	1400	750	1180	285	1000
119TA9774	1400x700	1600	750	1180	285	1000
119TA9777	1600x700	1800	750	1180	285	1000
119TA9772	1200x800	1400	850	1180	285	1000
119TA9775	1400x800	1600	850	1180	285	1000
119TA9778	1600x800	1800	850	1180	285	1000
3 shelves: high model						
119TA9779	800x520	1000	570	1860	285	1700
119TA9781	1000x520	1200	570	1860	285	1700
119TA9784	1200x520	1400	570	1860	285	1700
119TA9780	800x600	1000	650	1860	285	1700
119TA9782	1000x600	1200	650	1860	285	1700
119TA9785	1200x600	1400	650	1860	285	1700
119TA9788	1400x600	1600	650	1860	285	1700
119TA9791	1600x600	1800	650	1860	285	1700
119TA9783	1000x700	1200	750	1860	285	1700
119TA9786	1200x700	1400	750	1860	285	1700
119TA9789	1400x700	1600	750	1860	285	1700
119TA9792	1600x700	1800	750	1860	285	1700
119TA9787	1200x800	1400	850	1860	285	1700
119TA9790	1400x800	1600	850	1860	285	1700
119TA9793	1600x800	1800	850	1860	285	1700

* all dimensions are given in millimetres

ESD-proof table trolley with handle

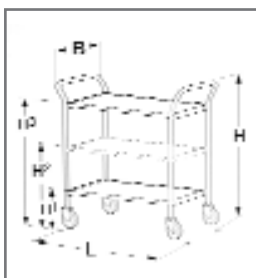

- ✓ 4 wheels with ball bearings 125 x 32 mm
- ✓ Shelves in conductive materials
- ✓ Load capacity 150 kg
Top shelf: 100 kg

REF	Shelf	L	W	H	H1	H2	H3	H4
2 shelves								
119TA9752	800x430	1140	460	980	240	-	810	526
3 shelves								
119TA9753	800x430	1140	460	980	240	525	810	-

ESD-proof table trolley without handle

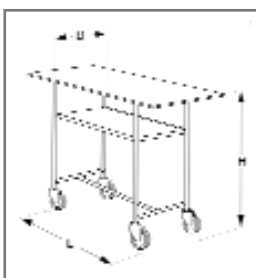

- ✓ 4 wheels with ball bearings 125 x 32 mm
- ✓ Shelves in conductive materials
- ✓ Load capacity 150 kg
Top shelf: 100 kg (large model)
50 kg (small model)

REF	Dimensions (mm)	L	W	H
119TA9741	600x430	600	430	1100
119TA9742	820x600	820	600	900
119TA9743	1200x600	1200	600	900

* all dimensions are given in millimetres

**Trolleys
for Euronorm boxes!**

ESD-proof dolly trolley



- ✓ 4 wheels with ball bearings 125 x 32 mm
- ✓ Suitable for 8 Euronorm boxes 600 x 400 mm
- ✓ Distance between rails: 165 mm
- ✓ Load capacity: 200 kg

REF	L	W	H	H1
119TA9740	670	465	1585	260

ESD-proof dollies and pallet dollies

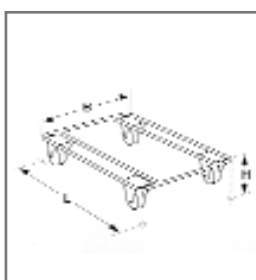

- ✓ Large and small dolly: 4 castors with ball bearings 125 x 32 mm
- ✓ Pallet dollies: 2 rigid castors and 2 castors
- ✓ Pallet dollies for Euro pallets, suitable for hand pallet truck
- ✓ Load capacity of dolly: 400 kg
- ✓ Load capacity of pallet dolly: 500 kg

REF	Shelf (mm)	L	W	H
Large dolly				
119TA9745	800x600	852	606	180
Small dolly				
119TA9744	600x400	652	410	180
Pallet dolly				
119TA9750	1 pallet	1042	815	165
Pallet dolly				
119TA9751	1/2 pallet	1042	815	165

* all dimensions are given in millimetres

- ✓ *Scooters: ideal for moving around in large warehouses!*
- ✓ *With basket or load area*
- ✓ *Available with kick-start motor*

Scooter with basket

**REF 119TA9384 (WITHOUT MOTOR)**

- ✓ Front wheel pneumatic 310 mm
- ✓ Rear wheel solid rubber 200 mm
- ✓ Handbrake on front wheel

REF 119TA9390

- ✓ With motor, battery and charger
- ✓ Kick 'n' go function: scooter starts and stops automatically
- ✓ Battery: autonomy for 1 working day

Scooter with load area

**REF 119TA9386**

- ✓ 3 non-marking rubber wheels with ball bearings: 200 x 46 mm
- ✓ Plastic laminated platform: 680 x 580 mm (protective grey rim)
- ✓ Supporting rail around platform
- ✓ Small turning circle
- ✓ Length: 1430 mm - Width: 680 mm - Platform height: 270 mm

REF 119TA9388

- ✓ Footbrake on rear wheel
- ✓ Wheels with roller bearings

REF 119TA9699

- ✓ With motor, battery and charger
- ✓ Length: 1540 mm - Width: 680 mm - Platform height: 270 mm

Accessories for scooters with a load area:

- 2nd load area - height-adjustable 660 x 425 mm
- Basket: 150 x 330 x 180 mm
- Clipboard
- Rim for platform 612 x 542 x 118 mm
- Tubular rim for platform 612 x 542 x 118 mm
- Padlock

* all dimensions are given in millimetres

REF 119TA9625



- ✓ *Easy-run office trolleys!*
- ✓ *The perfect combination of design and user friendliness!*

- ✓ 4 castors 100 x 25 mm
- ✓ Shelves finished in walnut or beech
- ✓ Height-adjustable - no tools required
- ✓ Shelf dimensions: 530 x 400 mm
- ✓ Basket dimensions: 400 x 350 x 220 mm
- ✓ Load capacity: 100 kg - Top shelf: 30 kg
Bottom shelf: 100 kg

Recyclable trolleys produced in an environmentally friendly way!

REF 119TA9627



REF 119TA9647



REF 119TA9631



REF 119TA9655



REF 119TA9651



REF 119TA9653



REF 119TA9641



REF 119TA9657



REF walnut	REF beech	Description	L	W	H	H1
119TA9625	119TA9643	2 shelves	750	455	1550	195
119TA9627	119TA9645	3 shelves	750	455	1550	195
119TA9629	119TA9647	2 file holders	750	455	1550	195
119TA9631	119TA9649	1 file holder	750	455	1550	195
119TA9637	119TA9655	1 basket - 2 shelves	750	455	1550	195
119TA9633	119TA9651	1 basket - 1 shelf	750	455	1550	195
119TA9635	119TA9653	2 baskets	750	455	1550	195
119TA9641	119TA9659	1 suspension file rack	750	455	1550	195
119TA9639	119TA9657	2 suspension file racks	750	455	1550	195

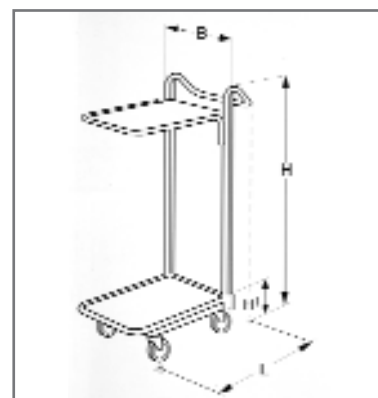

119TA9135 Accessory: suspension files

* all dimensions are given in millimetres

- ✓ 4 wheels with slide bearings 100 x 25 mm, 2 with brakes!
- ✓ Shelves in long-lasting laminate: can be used on either side!
- ✓ Frame in black, grey or gloss galvanized

Table trolley

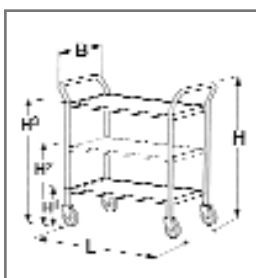

- ✓ Shelves in grey/grey or beech/walnut
- ✓ Load capacity: 150 kg
Per shelf: 100 kg

REF	Grey	Black	Chrome	Shelf	L	W	H	H1	H2	H3	Shelf
2 shelves											
119TA9474	119TA9482	119TA9466		800x420	1024	460	946	210	-	780	grey
119TA9476	119TA9484	119TA9468		800x420	1024	460	946	210	-	780	beech/walnut
119TA9478	119TA9486	119TA9470		1000x420	1224	460	946	210	-	780	grey
119TA9480	119TA9488	119TA9472		1000x420	1224	460	946	210	-	780	beech/walnut
3 shelves											
119TA9522	119TA9530	119TA9514		800x420	1024	460	946	210	495	780	grey
119TA9524	119TA9532	119TA9516		800x420	1024	460	946	210	495	780	beech/walnut
119TA9526	119TA9534	119TA9518		1000x420	1224	460	946	210	495	780	grey
119TA9528	119TA9536	119TA9520		1000x420	1224	460	946	210	495	780	beech/walnut

Table trolley with 2 shelves

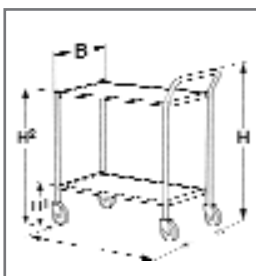

- ✓ Shelves in grey/grey or beech/walnut
- ✓ Load capacity: 150 kg
Per shelf: 100 kg

REF	Grey	Black	Chrome	Shelf	L	W	H	H1	H2	Shelf
2 shelves										
119TA9426	119TA9434	119TA9418		800x420	929	460	946	210	780	grey
119TA9428	119TA9436	119TA9420		800x420	929	460	946	210	780	beech/walnut
119TA9430	119TA9438	119TA9422		1000x420	1129	460	946	210	780	grey
119TA9432	119TA9440	119TA9424		1000x420	1129	460	946	210	780	beech/walnut

* all dimensions are given in millimetres

- ✓ 4 wheels 100 x 25 mm, 2 with brakes
- ✓ Frame in black, grey or gloss galvanized
- ✓ Shelves in long-lasting laminate: can be used on either side!

Table trolley without handle

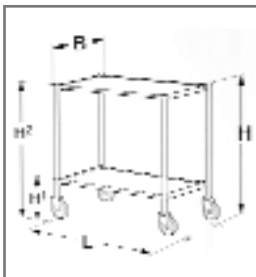

- ✓ Shelves in grey/grey or beech/walnut
- ✓ Load capacity: 150 kg
Per shelf: 100 kg

REF	Grey	Black	Chrome	Shelf	L	W	H	H1	H2	Shelf
2 shelves										
119TA9402	119TA9410	119TA9394	800x420	834	460	780	210	780		grey
119TA9404	119TA9412	119TA9396	800x420	834	460	780	210	780		beech/walnut
119TA9406	119TA9414	119TA9398	1000x420	1034	460	780	210	780		grey
119TA9408	119TA9416	119TA9400	1000x420	1034	460	780	210	780		beech/walnut

Table trolley with handle

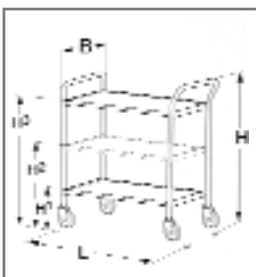

- ✓ Shelves in grey/grey or beech/walnut
- ✓ Load capacity: 150 kg
Per shelf: 100 kg

REF	Grey	Black	Chrome	Shelf	L	W	H	H1	H2	H3	Shelf
2 shelves											
119TA9450	119TA9458	119TA9442	800x420	929	460	946	210	-	780		grey
119TA9452	119TA9460	119TA9444	800x420	929	460	946	210	-	780		beech/walnut
119TA9454	119TA9462	119TA9446	1000x420	1129	460	946	210	-	780		grey
119TA9456	119TA9464	119TA9448	1000x420	1129	460	946	210	-	780		beech/walnut
3 shelves											
119TA9498	119TA9506	119TA9490	800x420	929	460	946	210	495	780		grey
119TA9500	119TA9508	119TA9492	800x420	929	460	946	210	495	780		beech/walnut
119TA9502	119TA9510	119TA9494	1000x420	1129	460	946	210	495	780		grey
119TA9504	119TA9512	119TA9496	1000x420	1129	460	946	210	495	780		beech/walnut

* all dimensions are given in millimetres

Office trolley

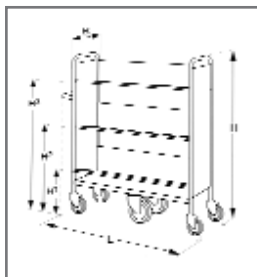

- ✓ Nylon castors with slide bearings: 100 x 35 mm (ESD version: 125 x 32 mm)
- ✓ Finish: beech laminate
- ✓ Low trolleys (1280 mm high) have a load capacity of 150 kg
- ✓ The high model (1340 mm high) has a load capacity of 250 kg
- ✓ Maximum load capacity per shelf: 100 kg

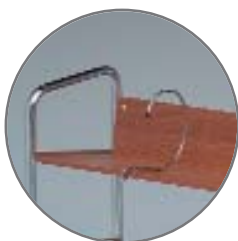

Accessories:

REF	Description
119TA9221	Extra book-end

REF	Shelf	L	W	H	H1min	H2max	H3
119TA9503	725x300	900	460	1280	315	690	1065
119TA9505	1005x300	1180	460	1280	315	690	1065
119TA9507	1005x300	1180	460	1340	365	745	1115
119TA9509	725x300	900	460	1280	315	690	1065
119TA9511	1005x300	1180	460	1280	315	690	1065
119TA9513	1005x300	1180	460	1340	365	745	1115

Supplied with 1 book-end per shelf!

Mobile desk

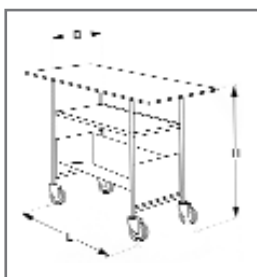

- ✓ 4 rubber castors: 125 x 32 mm
Smaller table: 100 x 25 mm
- ✓ Table top available in beech laminate or grey laminate (both materials are 19 mm thick)
- ✓ Load capacity small table: 50 kg
Load capacity larger table: 100 kg
- ✓ Sloped shelf is optional

Accessories:

REF	Dim. (mm)	Fits:
Sloped shelf 119TA9227	385x300	119TA9322 119TA9328
Sloped shelf 119TA9235	726x300	119TA9324 119TA9326
Box 119TA9223	370x150x80	All models
Brake 119TA9217	385x300	119TA9322 119TA9328 119TA9330 119TA9332
Dual brake 119TA9219	385x300	119TA9324 119TA9326 119TA9332 119TA9330
Book-end 119TA9221		All models

REF	Shelf	L	W	H
Beech laminate				
119TA9328	600x430	460	410	1060
119TA9330	820x600	800	460	900
119TA9332	1200x600	800	460	900
Grey laminate				
119TA9322	600x430	460	410	1060
119TA9324	820x600	800	460	900
119TA9326	1200x600	800	460	900

Bottom shelf height-adjustable!

* all dimensions are given in millimetres

Filing trolley

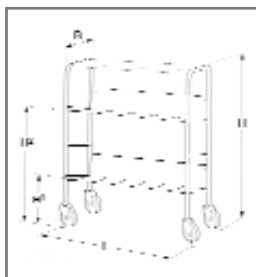

- ✓ 4 castors 100 x 25 mm
- ✓ Shelves in laminate, cherry or light oak
- ✓ 24 files per shelf
- ✓ 2 book-ends with each trolley
- ✓ Load capacity: 75 kg
Top shelf: 15 kg
Sloped shelf: 30 kg

Accessories:

REF	Description
119TA9221	Extra book-end
119TA9171	Brake on 4 wheels

REF	Shelf	L	W	H	H1	H2	Model
2 shelves							
119TA9360	750x290	800	350	840	280	690	cherry
119TA9364	750x290	800	350	840	280	690	oak
3 shelves							
119TA9362	750x290	800	350	1060	280	690	cherry
119TA9366	750x290	800	350	1060	280	690	oak

Office trolley



- ✓ 4 grey rubber castors with ball bearings 125 x 32 mm
- ✓ Shelves in grey laminate
- ✓ Handle with plastic cover
- ✓ Height-adjustable shelves
- ✓ Load capacity: 200 kg

REF	Shelf	L	W	H	H1min	Distance between shelves
119TA9517	620x425	800	460	940	270	350

* all dimensions are given in millimetres

Post trolley

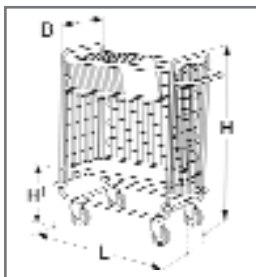

- ✓ Small trolley: castors 100 x 25 mm
Large trolley: castors 125 x 32 mm
- ✓ Small trolley: space for 10 suspension files + basket
- ✓ Large trolley: space for 15 suspension files + parcel shelf (3 mesh grids)

Accessories:

REF	Description	Dim. (mm)
119TA9135	Extra suspension files	370 x 420

REF	Shelf	L	W	H	H1min
119TA9619	n/a	640	400	1080	160
119TA9515	750x425	930	460	1120	270

Stainless steel table trolley

Designed for use in the chemical and food industries where water, moisture and salt are present. These stainless steel products are low-maintenance and comply with safety and hygiene standards!

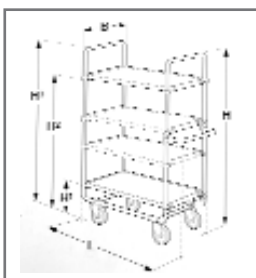

- ✓ 4 castors: 125 x 32 mm
- ✓ Grey wheels leave no marks
- ✓ Shelves: stainless steel panels
- ✓ Load capacity: 200 kg
Top shelf: 100 kg

Stainless steel

REF	Shelf	L	W	H	H1min	H2max	H3
2 shelves							
119TA9443	620x440	800	460	940	250	800	895
119TA9457	920x440	1100	460	940	250	800	895
119TA9451	850x600	1030	600	940	250	800	895
2 shelves (without handles)							
119TA9445	620x440	800	460	900	250	900	895
119TA9459	920x440	1100	460	900	250	900	895
119TA9453	850x600	1030	600	900	250	900	895
3 shelves							
119TA9447	620x440	800	460	1120	250	1050	1120
119TA9461	920x440	1100	460	1120	250	1050	1120
119TA9455	850x600	1030	600	1120	250	1050	1120
4 shelves							
119TA9449	620x440	800	460	1585	250	1500	1585
119TA9463	920x440	1100	460	1585	250	1500	1585

* all dimensions are given in millimetres

Mini-trolley



- ✓ 4 castors 100 x 25 mm
- ✓ Choice of design:
 - 2 shelves
 - 2 baskets
 - 1 basket and 1 shelf
- ✓ Top shelves and baskets are height-adjustable
- ✓ Load capacity: 35 kg - Per shelf: 10 kg
On chassis: 15 kg

REF	Shelf	L	W	H	H1min	Model
119TA9348	410x350	650	360	1065	160	2 shelves
119TA9350	-	650	360	1065	160	2 baskets
119TA9352	410x350	650	360	1065	160	1 shelf and 1 basket

Accessories:

REF	Descr.	Dim. (mm)
119TA9387	Basket	405x300x210
119TA9385	Shelf	410x350
119TA9171	Brake	n/a

Mobile clothes rails



- ✓ 4 castors in different sizes: 100 x 25 mm, 125 x 25 mm and 200 x 50 mm
- ✓ Available with Z-frame or robust tubular frame
- ✓ Available with 1 or 2 rows

REF	L	W	H	Number of rows	Wheels
Z-frame					
119TA9368	1530	660	1640	1	100x25 mm
119TA9370	1530	660	1670	1	125x32 mm
119TA9376	1530	660	2000	2	100x25 mm
119TA9378	1530	660	2030	2	125x32 mm
Tubular frame					
119TA9372	1570	630	1650	1	125x32 mm
119TA9374	1570	630	1740	1	200x50 mm
119TA9380	1570	630	2010	2	125x32 mm
119TA9382	1570	630	2100	2	200x50 mm

* all dimensions are given in millimetres

Rubbish sack trolleys

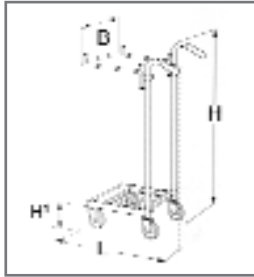

- ✓ 4 castors in different sizes: 100 x 25 or 50 mm
- ✓ 4 models for 125 litre sacks. The holder is height-adjustable

REF	L	W	H	H1min	Model	Wheels
119TA9354	650	360	1060	160	with handle	100 mm
119TA9356	650	360	1060	160	without handle	50 mm
119TA9358	650	360	1060	160	with lid	50 mm
121TA1043	800	460	1140	230	for 2 sacks	100 mm

* all dimensions are given in millimetres

The range of ergonomic trucks and trolleys offers an infinite variety of options.
 → *Contact us for a personalized quote!*

