



52 x 74 mm
REF 106TA9280

105 x 148 mm
REF 106TA9281



52 x 74 mm
REF 106TA9278

105 x 148 mm
REF 106TA9279



52 x 74 mm
REF 106TA9276

105 x 148 mm
REF 106TA9277



52 x 74 mm
REF 106TA9274

105 x 148 mm
REF 106TA9275



52 x 74 mm
REF 106TA9272

105 x 148 mm
REF 106TA9273



52 x 74 mm
REF 106TA9270

105 x 148 mm
REF 106TA9271



52 x 74 mm
REF 106TA9268

105 x 148 mm
REF 106TA9269



52 x 74 mm
REF 106TA9266

105 x 148 mm
REF 106TA9267



52 x 74 mm
REF 106TA9264

105 x 148 mm
REF 106TA9265



52 x 74 mm
REF 106TA9262

105 x 148 mm
REF 106TA9263

Note: Dutch text only!

100 x 100 mm
REF 106TA9288

148 x 148 mm
REF 106TA9289

200 x 200 mm
REF 106TA9290



7 pieces / card
REF 106TA9285

3 pieces / card
REF 106TA9286

1 piece
REF 106TA9287



7 pieces / card
REF 106TA9282

3 pieces / card
REF 106TA9283

1 piece
REF 106TA9284



REF 106TA9300



REF 106TA9296



REF 106TA9292



REF 106TA9299



REF 106TA9295



REF 106TA9291



REF 106TA9298



REF 106TA9294



REF 106TA9297



REF 106TA9293

*Adhesive labels on roll
33 m x 50 mm
- 600 labels/roll
- label size: 46mm(W)x64mm(L)*



TONGUE TERMINALS

TONGUE TERMINALS



Section mm ²	Ø d mm	REF / piece	Section mm ²	Ø d mm	REF / piece	Section mm ²	Ø d mm	REF / piece
6	4	106TA9301	25	5	123TA5451	70	6	106TA9327
	5	106TA9302		6	106TA9311		8	106TA9328
10	6	106TA9303		8	106TA9312		10	106TA9329
	8	106TA9304	10	106TA9313	14		106TA9330	
	10	106TA9305	12	106TA9314	16		106TA9331	
	12	106TA9306	35	6	106TA9315		95	10
16	5	123TA5450		8	106TA9316	12		106TA9333
	6	106TA9307		10	106TA9317	14		106TA9334
	8	106TA9308		12	106TA9318	120		10
	10	106TA9309		14	106TA9319		12	106TA9336
12	106TA9310	50		6	106TA9320		14	106TA9337
			8	106TA9321	16		106TA9338	
			10	106TA9322				
			12	106TA9323				
			14	106TA9324				
			16	106TA9325				

FLAG TERMINALS

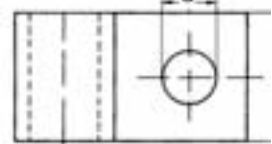

Section mm ²	Ø d mm	REF / piece	Section mm ²	Ø d mm	REF / piece
25	6	106TA9345	50	8	106TA9351
	8	106TA9346		10	116TA4347
	12	106TA9347		12	106TA9353
35	8	106TA9348	70	8	106TA9354
	10	106TA9349		10	106TA9352
	12	106TA9350		12	106TA9355

BUTT SPLICES



Section mm ²	REF / piece	Section mm ²	REF / piece	Section mm ²	REF / piece
10	106TA9389	35	106TA9386	95	106TA9385
16	106TA9390	50	106TA9387		
25	106TA9391	70	106TA9388		

90° BENT TERMINALS

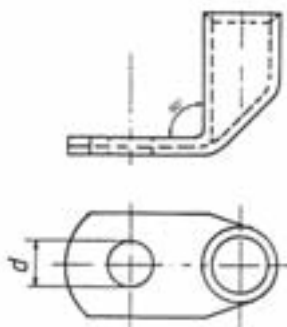

Section mm ²	Ø d mm	REF / piece	Section mm ²	Ø d mm	REF / piece
10	6	106TA9357	50	6	106TA9373
	8	106TA9358		8	106TA9374
	10	106TA9359		10	106TA9375
	12	106TA9360		12	106TA9376
16	6	106TA9361		14	106TA9377
	8	106TA9362		16	106TA9378
	10	106TA9363	70	6	106TA9379
	12	106TA9364		8	106TA9380
25	6	106TA9365		10	106TA9381
	8	106TA9366		12	106TA9382
	10	106TA9367		14	106TA9383
	12	106TA9368		16	106TA9384
35	8	106TA9369			
	10	106TA9370			
	12	106TA9371			
	14	106TA9372			



CONIC TERMINAL

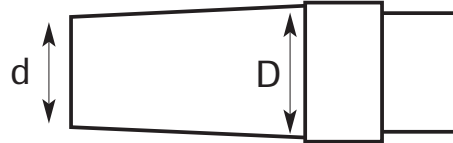

Type	d	D	REF / piece
Positive : 35-50 mm ²	16 mm	18,5 mm	REF 107TA9074
Negative : 35-50 mm ²	14 mm	16,5 mm	REF 107TA9075
Positive : 70-95 mm ²	16 mm	18,5 mm	REF 123TA6763
Negative : 70-95 mm ²	14 mm	16,5 mm	REF 123TA6764

BATTERY TERMINALS

BOLT-ON BATTERY TERMINALS



Type	REF / piece
Positive	106TA9403

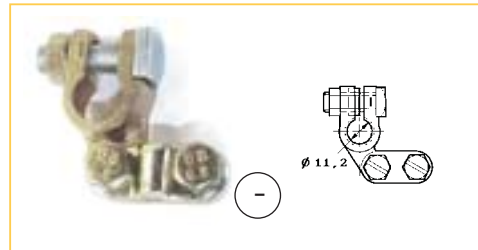

Type	REF / piece
Negative	106TA9402

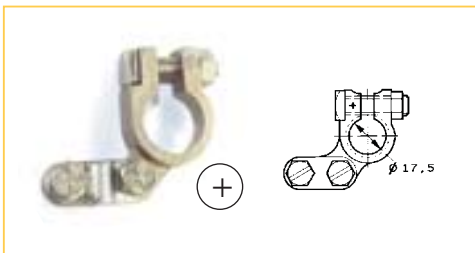

Type	REF / piece
Positive	106TA9405



Type	REF / piece
Negative	106TA9404



Type	Screw	REF / piece
Positive	M8	106TA9408
	M10	106TA9409

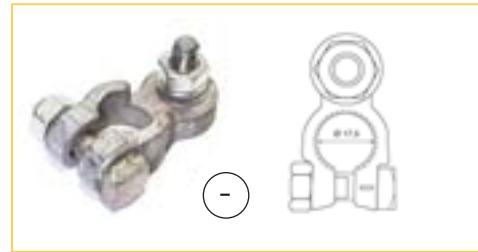

Type	Screw	REF / piece
Negative	M8	106TA9406
	M10	106TA9407

BOLT-ON BATTERY TERMINALS



Type	Section mm ²	REF / piece
Positive	M8	111TA3847



Type	Section mm ²	REF / piece
Negative	M8	111TA3848

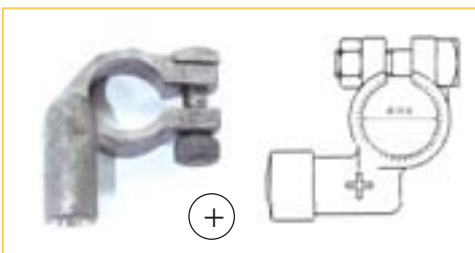

Section mm ²	REF / piece
10	106TA9397
16	106TA9398
25	106TA9399
35	106TA9400
50	106TA9401

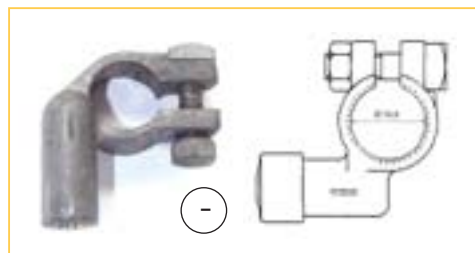

Section mm ²	REF / piece
10	106TA9392
16	106TA9393
25	106TA9394
35	106TA9395
50	106TA9396



Type	Section mm ²	REF / piece
Positive	50	106TA9411



Type	Section mm ²	REF / piece
Negative	50	106TA9410



Type	Section mm ²	REF / piece
Positive	70	106TA9413



Type	Section mm ²	REF / piece
Negative	70	106TA9412

BOLT-ON BATTERY TERMINALS



Type	Section mm ²	REF / piece
Positive	50	106TA9417



Type	Section mm ²	REF / piece
Negative	50	106TA9416



Type	Section mm ²	REF / piece
Positive	70	106TA9415



Type	Section mm ²	REF / piece
Negative	70	106TA9414



Type	Section mm ²	REF / piece
Positive	70	106TA9420
Positive	95	106TA9421



Type	Section mm ²	REF / piece
Negative	70	106TA9418
Negative	95	106TA9419



JUMP LEADS AND CLAMPS

CROCODILE CLIPS



+

RED
REF 112TA4801
250 A
REF 106TA9422
350 A

-

BLACK
REF 112TA4802
250 A
REF 106TA9423
350 A

JUMP LEADS



amp	diameter cable (mm)	cable length (metre)	REF
250 A	10	3,5	REF 112TA4803
350 A	10	4,5	REF 106TA9424

BATTERY TERMINALS

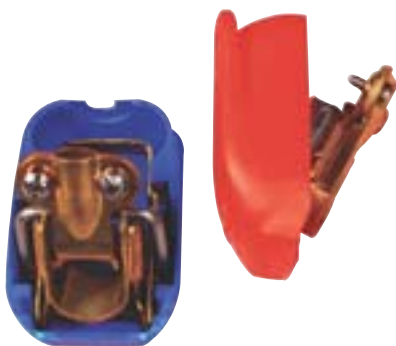

REF 106TA9425
quickfit type
(sold in pairs)

CLAMP WITH BRAID



REF 106TA6828
Clamp with braid
400 amp

CLAMP



-

REF 106TA6826
Clamp 40 amp

CLAMP



+

REF 106TA6827
Clamp 40 amp

CLAMP



-

REF 106TA6829
- Insulated crocodile clip
- Length: 90 mm
- Low current use

CLAMP



+

REF 106TA6830
- Insulated crocodile clip
- Length: 90 mm
- Low current use

FLEET ASSEMBLY SAFE-T-CONNECT

SAFE-T-CONNECT®

Fleet assembly includes:

- 1 fleet booster cable with connectors on both ends
- 2 vehicle harnesses
- 2 dust covers and mounting hardware

Fleet Booster Cable:

- Twin gauge Vu-Tron® welding cable
- 2 impact-resistant polycarbonate connector housings

REF 116TA5583

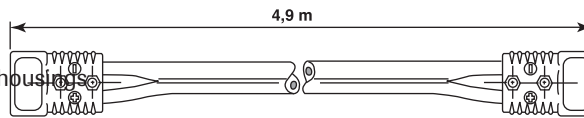

POLARITY INDICATOR

- Eliminates polarity mismatch

REF 116TA5584



BOOSTER CABLE ASSEMBLY SAFE-T-CONNECT

SAFE-T-CONNECT®

Booster cable assembly includes:

- 1 booster cable with or without polarity indicator
- 1 vehicle harness
- 1 dust cover and hardware

REF 116TA5586

7.6m booster assembly

REF 116TA5589

7.6m booster assembly with polarity indicator





All cable terminals are supplied in bags of 100 pieces.

For example:
if you order 3 times REF 106TA9428, you will receive 300 pieces.

CRIMP TERMINALS

Type	Colour	Section mm ²	Dimensions	REF / 100pieces	Type	Colour	Section mm ²	Dimensions	REF / 100pieces																				
1	RED	0,5-1,0	M 2,6	106TA9426	4	RED	0,5-1	2,8 x 0,5	106TA9463																				
			M 3	106TA9427				2,8 x 0,8		106TA9464																			
			M 4	106TA9428				4,8 x 0,5			106TA9465																		
			M 5	106TA9429				4,8 x 0,8				106TA9466																	
			M 6	106TA9430				6,3 x 0,8					106TA9467																
			M 8	106TA9431				7,7 x 0,8						106TA9468															
	M 10	106TA9432	4,8 x 0,5	106TA9469																									
	BLUE	1-2,5	M 3			106TA9433	6,3 x 0,8	106TA9470																					
			M 4			106TA9434	7,7 x 0,8								106TA9471														
			M 5			106TA9435	6,3 x 0,8									106TA9472													
			M 6			106TA9436	9,5 x 1,2										106TA9473												
			M 8			106TA9437	4-6											106TA9474											
M 10			106TA9438		RED	0,5-1			6,3 x 0,8										106TA9475										
YELLOW	4-6	M 4	106TA9439						BLUE	1-2,5										6,3 x 0,8	106TA9476								
		M 5	106TA9440								YELLOW									4-6		Ø 4	106TA9477						
		M 6	106TA9441									RED										0,5-1		Ø 5	106TA9478				
		M 8	106TA9442										BLUE											1-2,5		Ø 4	106TA9479		
		M 10	106TA9443				YELLOW							4-6												Ø 5		106TA9480	
		2	RED	0,5-1,0	M 3	106TA9444																				5			RED
M 3,5	106TA9445				BLUE	1-2,5		6,3 x 0,8	106TA9482																				
M 4	106TA9446							YELLOW		4-6	Ø 5				106TA9483														
M 5	106TA9447										RED	0,5-1				Ø 4				123TA5434									
M 6	106TA9448												BLUE			1-2,5	Ø 5					106TA9485							
BLUE	1-2,5						M 3							106TA9449			YELLOW	4-6						Ø 5					
		M 3,5	106TA9450	RED			0,5-1							6,3 x 0,8					106TA9487										
		M 4	106TA9451		BLUE	1-2,5								6,3 x 0,8							106TA9488								
		M 5	106TA9452					YELLOW		4-6				6,3 x 0,8									106TA9489						
		M 6	106TA9453								RED	0,5-1		6,3 x 0,8										106TA9490					
		YELLOW	4-6										M 4	106TA9454		BLUE									1-2,5		6,3 x 0,8		106TA9491
M 5	106TA9455												YELLOW	4-6			L = 17 mm	106TA9492											
M 6	106TA9456			RED			0,5-1										L = 25 mm									106TA9493			
M 8	106TA9457				BLUE	1-2,5			L = 17 mm								106TA9494												
M 10	106TA9458							YELLOW	4-6	L = 25 mm					106TA9495														
3	RED									0,5-1		106TA9459								10							RED	0,5-1,0	
		BLUE	1-2,5									106TA9460				BLUE						1-2,5			L = 27 mm				
											YELLOW	4-6		106TA9461											YELLOW				



WIRE TERMINAL KIT

50 x L= 6,3 x 0,8
 50 x L=25 mm
 50 x 6,3 x 0,8

50 x M4
 50 x M5
 50 x M6
 50 x M8
 50 x L = 25 mm
 50 x Ø 4
 50 x 6,3 x 0,8
 50 x Ø 4
 50 x 6,3 x 0,8

REF 116TA9279
 With professional ratchet crimping tool

WIRE TERMINAL KIT

10 x M4
 10 x M4
 10 x M5
 10 x L = 25 mm
 10 x M4
 10 x M5
 10 x L = 25 mm
 10 x 6,3 x 0,8
 10 x 6,3 x 0,8
 10 x 6,3 x 0,8

REF 116TA7803
 With standard crimping tool

CRIMP TERMINALS AND TOOLS

WIRE TERMINAL KIT (WIRE END SLEEVES)

100 x 0,50 mm²
 400 x 0,75 mm²
 400 x 1,00 mm²
 400 x 1,50 mm²
 200 x 2,50 mm²
 100 x 4,00 mm²
 60 x 6,00 mm²
 40 x 10,00 mm²

REF 111TA3851
 With crimping tool

TERMINAL BLOCKS



- 12-way
- temperature -25° to 100°C
- quality polypropylene
- EN 60998

Wire size	REF
4 mm ²	112TA4807
6 mm ²	112TA4808
10 mm ²	112TA4809
16 mm ²	112TA4810



STANDARD CRIMPING TOOL



REF 106TA9500

Able to:

- cut
- crimping terminals for cable sizes from 1.5 to 6 mm²

PROFESSIONAL CRIMPING TOOL



REF 106TA9498

Ratchet crimping tool suitable for cable sizes from 0.75 to 6 mm²

CABLE CUTTER



REF 106TA9499

Sizes:

Solid cable: Ø 25 mm
Multistrand cable: Ø 32 mm

CABLE STRIPPER



REF 111TA3850

For insulated cables from Ø 4,5 to 25 mm
Wire stripper with integrated cutter.

Accessory:

Replacement knife

REF 111TA3854

WIRE STRIPPER



REF 119TA4354

- Wire size 0,5 to 6 mm².
- Wire stripper with integrated cutter.
- Adjustable cutting length.

MANUAL MECHANICAL PRESS WITH DIE SETS



REF 111TA3852

- Wire size: 6 to 50 mm²
- Length: ca. 390 mm

REF 111TA3853

- Wire size: 10 to 120 mm²
- Length: ca. 650 mm

AUTOMATIC WIRE STRIPPER



REF 123TA5435

- Wire size: 0,2 to 6 mm²
- Automatic wire stripper for flexible and solid cables
- Weight: 0,130 kg

MANUAL HYDRAULIC PRESS



REF 106TA9502 (supplied without dies)

- Swivelling head to 180°
- Force : 60 kN
- Duplicate piston for fast crimping
- Pressure relief valve
- Length 490 mm

MANUAL MECHANICAL PRESS



REF 106TA9501 (supplied without dies)

- Swivelling head to 360°
- Force : 60 kN
- Interchangeable dies
- Length 600/850 mm
- Two telescopic handles

DIE SETS FOR HYDRAULIC AND MECHANICAL PRESS



DIN wire size	AWG wire size	REF	
		hydr.press	mec.press
10 mm ²	6 AWG	107TA8383	107TA8391
16 mm ²		107TA8380	107TA8384
25 mm ²		107TA8385	107TA8392
35 mm ²	1/0 AWG	107TA8386	107TA8393
50 mm ²		107TA8381	107TA8387
70 mm ²	2/0 AWG	107TA8388	107TA8394
95 mm ²		107TA8382	107TA8389
	4/0 AWG	107TA8390	107TA8395
		107TA8396	107TA8398
	3/0 AWG	107TA8397	107TA8399



2 POLE

REF 106TA9514
Male housing

2 POLE

REF 106TA9511
Male wedge

2 POLE

REF 106TA9508
Female housing

2 POLE

REF 106TA9505
Female wedge

3 POLE

REF 106TA9513
Male housing

3 POLE

REF 106TA9510
Male wedge

3 POLE

REF 106TA9507
Female housing

3 POLE

REF 106TA9504
Female wedge

4 POLE

REF 106TA9512
Male housing

4 POLE

REF 106TA9509
Male wedge

4 POLE

REF 106TA9506
Female housing

4 POLE

REF 106TA9503
Female wedge

6 POLE

REF 106TA9531
Male housing

6 POLE

REF 106TA9528
Male wedge

6 POLE

REF 106TA9525
Female housing

6 POLE

REF 106TA9522
Female wedge

**We have a large product range of connectors!
Please call us for further details!**



8 POLE



REF 106TA9530
Male housing

8 POLE



REF 106TA9527
Male wedge

8 POLE



REF 106TA9524
Female housing

8 POLE



REF 106TA9521
Female wedge

12 POLE



REF 106TA9529
Male housing

12 POLE



REF 106TA9526
Male wedge

12 POLE



REF 106TA9523
Female housing

12 POLE



REF 106TA9520
Female wedge

MALE PIN (SOLD PER 50 PCS.)



REF 123TA5437
For wire sizes 0,75 - 1,5 mm²
REF 123TA5438
For wire sizes 1,5 - 2,5 mm²

FEMALE SOCKET (SOLD PER 50 PCS.)



REF 123TA5439
For wire sizes 0,75 - 1,5 mm²
REF 123TA5440
For wire sizes 1,5 - 2,5 mm²

EXTRACTION TOOL



REF 111TA3870

CAVITY PLUG



REF 111TA3871

CRIMPING TOOL



REF 106TA9517
For wire sizes 0,75 - 2,5 mm²



AMP FASTIN-FASTON - SIZE 6,3 MM

1 POLE



REF 106TA9539
Male housing

1 POLE



REF 106TA9537
Female housing

2 POLE



REF 106TA9538
Male housing

2 POLE



REF 106TA9536
Female housing

2 POLE



REF 106TA9535
Male housing

2 POLE



REF 106TA9533
Female housing

4 POLE



REF 106TA9534
Male housing

4 POLE



REF 106TA9532
Female housing

6 POLE



REF 106TA9549
Male housing

6 POLE



REF 106TA9547
Female housing

8 POLE



REF 106TA9548
Male housing

8 POLE



REF 106TA9546
Female housing

MALE PIN (SOLD PER 50 PCS.)



REF 123TA5430
Wire size 0,3 - 0,8 mm²
REF 123TA5431
Wire size 0,8 - 2,1 mm²

FEMALE SOCKET (SOLD PER 50 PCS.)



REF 123TA5432
Wire size 0,5 - 1,5 mm²
REF 123TA5433
Wire size 1,0 - 2,5 mm²

EXTRACTION TOOL



REF 106TA9543

CRIMPING TOOL



REF 106TA9540
For wire sizes 1-2,5 mm²



2 POLE



REF 106TA9557
Male housing

2 POLE



REF 106TA9555
Female housing

3 POLE



REF 106TA9556
Male housing

3 POLE



REF 106TA9554
Female housing

4 POLE



REF 106TA9553
Male housing

4 POLE



REF 106TA9551
Female housing

6 POLE



REF 106TA9552
Male housing

6 POLE



REF 106TA9550
Female housing

9 POLE



REF 106TA9567
Male housing

9 POLE



REF 106TA9565
Female housing

12 POLE



REF 106TA9566
Male housing

12 POLE



REF 106TA9564
Female housing

15 POLE



REF 106TA9563
Male housing

15 POLE



REF 106TA9561
Female housing

MALE PIN (SOLD PER 50 PCS.)



REF 123TA5441
Wire size 0,5-2,1 mm²

FEMALE SOCKET (SOLD PER 50 PCS.)



REF 123TA5442
Wire size 0,5-2,1 mm²

EXTRACTION TOOL



REF 106TA9559

CRIMPING TOOL



REF 106TA9558
For wire sizes 0,5-2,1mm²

AMP-UNIVERSAL MATE-N-LOCK



MINI-FIT JUNIOR

2 POLE



REF 123TA5453
Female housing



2 POLE



REF 123TA5454
Male housing



4 POLE



REF 123TA5455
Female housing

4 POLE



REF 123TA5456
Male housing

6 POLE



REF 123TA5457
Female housing

6 POLE



REF 123TA5458
Male housing

8 POLE



REF 123TA5459
Female housing

8 POLE



REF 123TA5460
Male housing

EXTRACTION TOOL



REF 123TA7633

MALE PIN (SOLD PER 50 PCS.)



REF 123TA5461
Wire size: 0,25 - 0,75mm²
REF 123TA5462
Wire size: 1,5mm²

FEMALE SOCKET (SOLD PER 50 PCS.)



REF 123TA5463
Wire size: 0,25 - 0,75mm²
REF 123TA5464
Wire size: 1,5mm²

CRIMPING TOOL



REF 124TA1147
Wire sizes 0.25 mm² - 1.5 mm²

2 POLE + BLACK



REF 123TA7634
gasket included

2 POLE + BLACK



REF 123TA7635
gasket included

2 POLE + BLACK



REF 123TA7636

3 POLE + BLACK



REF 123TA7637

3 POLE + GRAY



REF 123TA7638

GASKIT



REF 123TA7639
flat gasket

REF 123TA7640
profile gasket

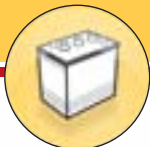

3 POLE



REF 106TA9574
Male housing

3 POLE



REF 106TA9573
Female housing

AMP-ECONOSEAL

8 POLE



REF 106TA9572
Male housing

8 POLE



REF 106TA9570
Female housing

MALE PIN (SOLD PER 50 PCS.)



REF 123TA5443
Wire size 0,75-1,5 mm²

FEMALE SOCKET (SOLD PER 50 PCS.)



REF 123TA5444
Wire size 0,75-1,5 mm²

EXTRACTION TOOL



REF 106TA9568

CRIMPING TOOL



REF 106TA9558
For wire sizes 0,5-2,1mm²







BRAIDS

BRAIDS

GENERAL USE



Tinned copper - sold per metre			
	8 mm	35 Amp	REF 106TA9575
	24 mm	100 Amp	REF 106TA9576
	10 mm	110 Amp	REF 106TA9577
	13 mm	260 Amp	REF 106TA9578



TAILOR MADE



USED FOR STILL, LINDE



REF 106TA7114

L1 = 75 mm
D1 = 9 mm
D2 = 6,2 mm

USED FOR HYSTER, YALE, CLARK



REF 103TA1517

L1 = 59 mm
D1 = 8,5 mm
D2 = 6,5 mm

USED FOR TOYOTA



REF 106TA7115

(3 braids)
L1 = 61 mm
D1 = 8,3 mm
D2 = 5,3 mm

**USED FOR CLARK, NISSAN
KOMATSU, TCM**



REF 106TA7116

L1 = 57 mm
D1 = 4,2 mm
D2 = 4,2 mm

USED FOR FENWICK



REF 106TA7117

L1 = 97 mm
D1 = 7 mm
D2 = 5,5 mm

USED FOR STILL, SAXBY



REF 106TA7118

L1 = 315 mm
D1 = 8 mm
D2 = 8 mm



USED FOR TOYOTA

**REF 106TA7120**

(double braid)

L1 = 61 mm

D1 = 8,3 mm

D2 = 5,3 mm

USED FOR LINDE

**REF 106TA7121**

L1 = 204 mm

D1 = 14 mm

D2 = 14 mm

USED FOR FENWICK

**REF 106TA7122**

L1 = 350 mm

D1 = 15,9 mm

D2 = 10,2 mm

USED FOR CROWN, YALE
CLARK, RAYMOND, BAKER**REF 106TA7123**

L1 = 125 mm

D1 = 6,7 mm

D2 = 6,7 mm

USED FOR KOMATSU, FENWICK

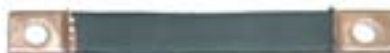
**REF 106TA7124**

L1 = 118 mm

D1 = 8,6 mm

D2 = 8,6 mm

USED FOR FENWICK

**REF 106TA7125**

L1 = 99 mm

D1 = 6,3 mm

D2 = 5,2 mm

USED FOR HYSTER

**REF 106TA7126**

L1 = 133,5 mm

D1 = 9 mm

D2 = 9 mm

USED FOR HYSTER, YALE
CLARK**REF 106TA7119**

L1 = 61

D1 = 6,5 mm

D2 = 4,4 mm

USED FOR STILL, LINDE

**REF 106TA7112**

L1 = 81 mm

D1 = 9 mm

D2 = 6,5 mm

USED FOR MIC, JUNGHEINRICH

**REF 106TA7113**

L1 = 68 mm

D1 = 8,5 mm

D2 = 5,2 mm

**For other types of
braids not shown,
please call us!**



BATTERY CABLE

Special quantity discount !
SPECIAL OFFER

- Rated voltage U_0/U 100/100V
- Tested in conformity with DIN VDE0472
- Extra flexible

SOLD PER METRE

Black	REF	Orange	REF
10 mm ²	106TA9586	10 mm ²	106TA9579
16 mm ²	106TA9587	16 mm ²	106TA9580
25 mm ²	106TA6745	25 mm ²	106TA9581
35 mm ²	106TA9588	35 mm ²	106TA9582
50 mm ²	106TA9589	50 mm ²	106TA9583
70 mm ²	106TA9590	70 mm ²	106TA9584
95 mm ²	106TA9591	95 mm ²	106TA9585

SOLD PER 25 METRE

Black	REF	Orange	REF
10 mm ²	123TA7647	10 mm ²	123TA7653
16 mm ²	123TA7648	16 mm ²	123TA7654
25 mm ²	123TA7649	25 mm ²	123TA7655
35 mm ²	123TA7650	35 mm ²	123TA7656
50 mm ²	123TA7651	50 mm ²	123TA7657
70 mm ²	123TA7652	70 mm ²	123TA7658

Number of cores cross-sectional mm ²	Overall diameter, mm	
	min	max
10	7.7	9.7
16	8.8	11.0
25	10.1	12.7
35	11.4	14.2
50	13.2	16.5
70	15.3	19.2
95	17.1	21.4

Nominal cross section	Loading current in Amp for the following duty cycles			
	100%	85%	60%	30%
mm ²				
16	135	145	175	245
25	180	195	230	330
35	225	245	290	410
50	285	310	370	520
70	355	385	460	650
95	430	470	560	790



3-CORE CABLE USED FOR LANSING



Number of cores	x	section (mm ²)	REF / metre
3	x	16	106TA9597

BATTERY CABLE

TWINFLEX CABLE RED & BLACK



Extra flexible	REF
2 x 6 mm ²	106TA9592
2 x 10 mm ²	112TA4812
2 x 16 mm ²	106TA9593
2 x 25 mm ²	106TA9594
2 x 35 mm ²	106TA9595
2 x 50 mm ²	106TA9596



HAND MEASURING DEVICE FOR CABLE



REF 123TA7642

- Cable diameter: 4-35mm
- Measure range: 0-9999,9m
- Tolerance: ± 1%



RUBBER INSULATED MULTIPOLE ROUND CABLE



H05RR-F

Number of cores	x	section (mm ²)	REF / metre
2	x	0.75	107TA8400
3	G	0.75	107TA8401
4	G	0.75	107TA8402

'G' indicates with Ground (Green / Yellow) cable



H07RN-F

Number of cores	x	section (mm ²)	REF / metre
2	x	1.5	106TA9608
2	x	2.5	106TA9609
2	x	6	106TA9610
3	G	1.5	106TA9612
3	G	2.5	106TA9613
3	G	10	106TA9614
4	G	1.5	106TA9616
4	G	2.5	106TA9617
4	G	6	106TA9618
4	G	10	106TA9619
4	G	16	106TA9620
5	G	1.5	106TA9621
5	G	2.5	106TA9622
5	G	4	106TA9623
5	G	6	106TA9624
7	G	1.5	106TA9626
7	G	2.5	106TA9627

'G' cable indicates with Ground (Green / Yellow)

PVC-INSULATED SINGLE-CORE CABLES



Sold in boxes per 100 metre

VTB-S / VOB-S

Section (mm ²)	Colour	REF / box (100 m)	Section (mm ²)	Colour	REF / box (100 m)	
0.34	Yellow	111TA3936	1.5	Blue	111TA3965	
	Red	111TA3937		Brown	111TA3966	
	Blue	111TA3938		Yellow	111TA3967	
	Brown	111TA3939		Green/Yellow	111TA3968	
	Grey	111TA3940		Grey	111TA3969	
	Pink	111TA3941		Green	111TA3970	
	Violet	111TA3942		Orange	111TA3971	
	White	111TA3943		Purple	111TA3972	
	Black	111TA3944				
	0.5	Grey		111TA3945	1.5	Red
Red		111TA3946	White	111TA3974		
White		111TA3947	Black	111TA3975		
Blue		111TA3948	2.5	Blue	111TA3976	
Brown	111TA3949	Brown		111TA3977		
Violet	111TA3950	Green/Yellow		111TA3978		
Black	123TA5449	Yellow		111TA3979		
		Grey		111TA3980		
		Green		111TA3981		
0.75	Blue	111TA3951	4	Brown	111TA3986	
	Brown	111TA3952		Grey	111TA3987	
	Yellow	111TA3953		Red	111TA3988	
	Green/Yellow	111TA3954		White	111TA3989	
	Grey	111TA3956		Black	111TA3990	
	Green	111TA3955		6	Blue	111TA3991
	Orange	111TA3957			Brown	111TA3992
	Red	111TA3958			Grey	111TA3993
Violet	111TA3959	Red	111TA3994			
White	111TA3960	Black	111TA3995			
Black	111TA3961					
1	Black	111TA3962				
	Brown	111TA3964				

MULTIPOLE CABLE - USED FOR CROWN

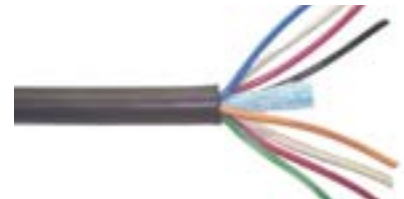

3 Cores
 Sold per foot
 Sold per roller of 250 feet
 Sold per roller of 500 feet

REF 106TA9604
REF 106TA9605
REF 106TA9606

5 Cores
 Sold per foot
 Sold per roller of 250 feet
 Sold per roller of 500 feet

REF 106TA9601
REF 106TA9602
REF 106TA9603

8 Cores
 Sold per foot
 Sold per roller of 250 feet
 Sold per roller of 500 feet

REF 106TA9598
REF 106TA9599
REF 106TA9600

1 foot = 0.305m



HARD WEARING CABLE



H05BQ-F

Number of cores	x	section (mm ²)	REF / metre
3G	1		111TA3855

'G' indicates with Ground (Green / Yellow) cable

PVC-INSULATED NUMBERED MULTIPOLE CABLE



LIYY

Number of cores	x	section (mm ²)	REF / metre
2	x 1.5		111TA3856
3	x 0.5		111TA3857
3	x 1		111TA3858
4	x 0,75		111TA3859
4	G 1.5		111TA3860
5	G 1.5		111TA3861
12	G 0,75		111TA3862
12	G 1.5		111TA3863
18	G 0,5		112TA4813
18	G 1		111TA3864

'G' indicates with Ground (Green / Yellow) cable

PVC-INSULATED NUMBERED MULTIPOLE CABLE



LIYY

Number of cores	x	section (mm ²)	REF / metre
2	x 2.5		111TA3865
4	x 2.5		111TA3866

RUBBER-INSULATED MULTIPOLE FLAT CABLE



NEOFLEX

Number of cores	x	section (mm ²)	REF / metre
4	G 10		111TA3867
4	G 25		111TA3868

'G' indicates with Ground (Green / Yellow) cable

AUTOCABLE



AK

Number of cores	x	section (mm ²)	REF / metre
2	x 1,5		111TA3869



CABLE HARNESSSES



The cables shown are part of a wide range of harness assemblies.

Any kind of assembly can be produced.

To order:
Please send your inquiry with original part numbers to ensure correct specifications.

SPECIAL 3-CORE HARNESSSES USED FOR LANSING



Part number

271 / LA2032543001
271 / LA2032543002
271 / LA2032543003
271 / LA2032543004
271 / LA3005592001
271 / LA3005593001
271 / LA3005594001
271 / LA3006198001
271 / LA3018427001
271 / LA3018428001
271 / LA3022067001
271 / LA3022066001
271 / LA3022065001

Our order reference

REF 105TA2727
REF 105TA2728
REF 105TA2729
REF 105TA2730
REF 105TA2731
REF 105TA2732
REF 105TA2733
REF 105TA2734
REF 105TA2735
REF 105TA2736
REF 105TA2737
REF 105TA2738
REF 105TA2739

OEM references are purely indicative and do not imply that parts originate from the forklift manufacturer.

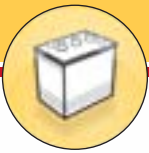

WIRE HARNESSES USED FOR FIAT - PIMESPO



260/FI95310068



REF 109TA3982
Length: 1740mm

260/FI9456790



REF 123TA7659
Length: 490mm

WIRE HARNESSES

WIRE HARNESSES USED FOR ATLET



506/AT100158



REF 118TA2072
Length: 1810mm

506/AT56091



REF 109TA4319
Length: 2225mm

WIRE HARNESSES USED FOR BT



268/BT201344-850



REF 123TA7662
Length: 11290mm

268/BT164748



REF 123TA7661 • repair kit
Length: 12840mm

OEM references are purely indicative and do not imply that parts originate from the forklift manufacturer.



WIRE HARNESSSES USED FOR CLARK

007/CL2384504



REF 109TA4600
Length: 2630mm

007/CL4305473



REF 118TA3033
Length: 2820mm

007/CL4340031



REF 118TA3469
Length: 2100mm

007/CL3738489



REF 123TA7663
Length: 890mm

007/CL4339755



REF 118TA2920
Length: 4550mm

007/CL4316721

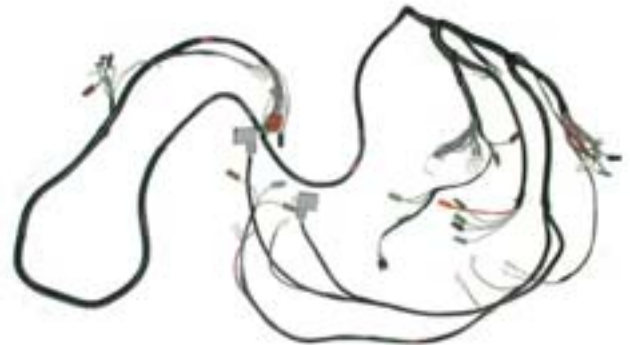

REF 109TA4412
Length: 3600mm

OEM references are purely indicative and do not imply that parts originate from the forklift manufacturer.

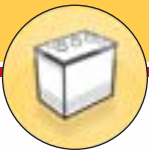
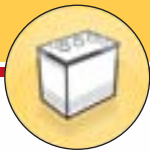

WIRE HARNESSES USED FOR JUNGHEINRICH

WIRE HARNESSES

269/JU69304800



REF 123TA7664
Length: 1900mm

269/JU69264250



REF 123TA7665
Length: 1430mm

269/JU69304810



REF 123TA8028
Length: 1990mm

269/JU50031143



REF 118TA3896
Length: 1380mm

269/JU77900011



REF 118TA1819
Length: 1930mm

269/JU50059779



REF 118TA3582
Length: 3400mm

OEM references are purely indicative and do not imply that parts originate from the forklift manufacturer.



WIRE HARNESSSES USED FOR LINDE - LANSING

400/LI1423800500



REF 109TA3994
Length: 630mm

400/LI3513810505



REF 123TA7666
Length: 2610mm

400/LI0009700807



REF 123TA7667
Length: 1638mm

400/LI3513810507



REF 123TA8029
Length: 2715mm

400/LI3523810507



REF 123TA8030
Length: 2740mm

400/LI1423800503



REF 109TA3901
Length: 720mm

OEM references are purely indicative and do not imply that parts originate from the forklift manufacturer.

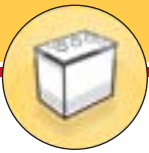
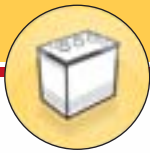

WIRE HARNESSES USED FOR MIC

WIRE HARNESSES

258/MI059610820



REF 123TA7668
Length: 805mm

258/MI068330000

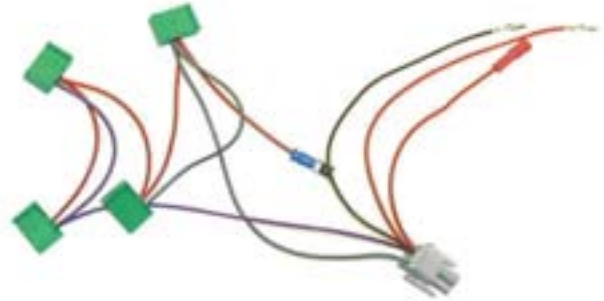

REF 118TA1831
Length: 365mm

258/MI061214003



REF 109TA4061
Length: 2140mm

258/MI059610067



REF 118TA1822
Length: 2580mm

258/MI055731002



REF 109TA3969
Length: 1435mm

258/MI65238

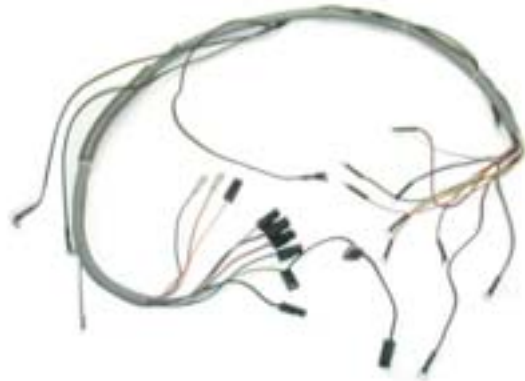

REF 123TA8031
Length: 1260mm

OEM references are purely indicative and do not imply that parts originate from the forklift manufacturer.



WIRE HARNESSSES USED FOR STILL

255/ST8345333



REF 123TA7669
Length: 1080mm

255/ST4352251



REF 123TA7670
Length: 1450mm

255/ST4365021



REF 116TA4624
Length: 500mm

255/ST4364990



REF 116TA4631
Length: 1940mm

255/ST8315845



REF 109TA4096
Length: 1010mm

255/ST4365010



REF 116TA4646
Length: 1010mm

OEM references are purely indicative and do not imply that parts originate from the forklift manufacturer.



CABLE CHAINS

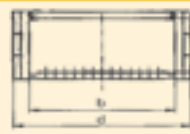

used for	truck type	width (mm)		length/ no. of links	REF
		d	b		
BT	CTX1300SEI	105	87	1 metre/22 links	106TA9696



used for	truck type	width (mm)		length/ no. of links	REF
		d	b		
Steinbock/Boss Jungheinrich	WJ15/WM10	74	58	1 metre/22 links	106TA9694
	-	74	58	1 link	106TA9695



used for	truck type	width (mm)		length/ no. of links	REF
		d	b		
Jungheinrich	ETX200/ETX-K125	54	38	1 metre/22 links	106TA9692
		54	38	1 link	106TA9693



used for	truck type	width (mm)		length/ no. of links	REF
		d	b		
Jungheinrich	ETX-K125	119	103	1 metre/22 links	106TA9690
		119	103	1 link	106TA9691



used for	truck type	width (mm)		length/ no. of links	REF
		d	b		
Kalmar	DC35000	86	75	1,8 metre	106TA9689
	DC45000				
	DC4160RS				



used for	truck type	width (mm)		length/ no. of links	REF
		d	b		
Kalmar	DC35000	75	59	1,8 metre	106TA9688
	DC45000				



used for	truck type	width (mm)		length/ no. of links	REF
		d	b		
Still/Saxby	MAXI464	121	115	1 link	106TA9687

This is only a small selection of types available. Please call us for other types!

Send us your inquiry with:

- OE-partnumber or,
- Truck type and serialnumber or,
- Make, type and dimensions of the cable chain.



HEAT SHRINK TUBING 3/1

before crimping



after crimping



D (mm)	D (inch)	d (mm)	colour	REF / metre
1,6	1/16"	0.5	black	106TA9697
3,2	1/8"	1	black	106TA9698
6,4	1/4"	2	transparent	106TA9699
			black	106TA9700
			red	106TA9701
			blue	106TA9702
9,5	3/8"	3	transparent	106TA9703
			black	106TA9704
12,7	1/2"	4	red	106TA9705
			blue	106TA9706
			transparent	106TA9707
			black	106TA9708
			green	106TA9709
19	3/4"	6	red	106TA9710
			blue	106TA9711
			black	106TA9712
			yellow	106TA9713
			green	106TA9714
25,4	1"	8	transparent	106TA9715
			black	106TA9716
39	1" 1/2	13	transparent	106TA9717
			black	106TA9718



BLOWTORCH



REF 123TA7641

Heat setting: 100-600 °C
 Airflow rate: 300-550 l/min
 Power input: 240V-200 W
 Weight: 0,7 kg

HEAT SHRINK TUBING KIT 2/1



HEAT SHRINK TUBING KIT: REF 111TA4116

Size		Colour	Length (m)	Pieces
D	d			
3,2	1,6	black	0,05	15
3,2	1,6	blue	0,05	15
3,2	1,6	yellow	0,05	15
3,2	1,6	red	0,05	15
3,2	1,6	white	0,05	15
4,8	2,4	black	0,05	6
4,8	2,4	blue	0,05	6
4,8	2,4	yellow	0,05	6
4,8	2,4	red	0,05	6
4,8	2,4	white	0,05	6
9,5	4,8	black	0,05	10
9,5	4,8	blue	0,05	10
9,5	4,8	yellow	0,05	10
9,5	4,8	red	0,05	10
9,5	4,8	white	0,05	10
12,7	6,4	black	0,07	5
12,7	6,4	blue	0,07	5
12,7	6,4	yellow	0,07	5
12,7	6,4	red	0,07	5
12,7	6,4	white	0,07	5

HEAT SHRINK TUBING

HEAT SHRINK TUBING WITH THERMOPLASTIC ADHESIVE

This flexible heat-shrink tubing is ideal for effective moisture-resistant insulation of electric connections.

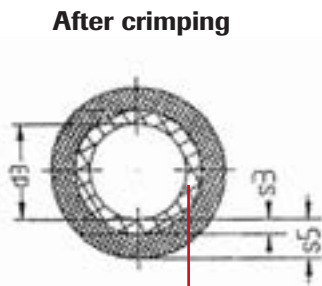
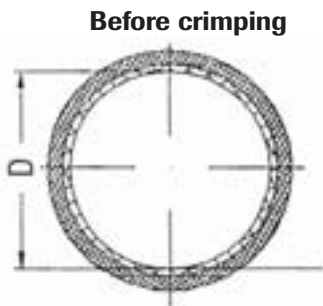

Thermoplastic adhesive

Before crimping		After crimping		Colour	REF / metre
D (mm)	d3(mm)	S3(mm)	S5(mm)		
19	6	0.60	2.10	Black	106TA9732
24	6	0.70	2.40	Black	106TA9733
32	8	0.70	2.40	Black	106TA9734
40	13	0.70	2.40	Black	106TA9735
52	13	0.70	2.40	Black	106TA9736



PVC-TUBING (NON SHRINKABLE)



D(mm)	colour	REF / metre
4	Black	106TA9724
5	Black	106TA9725
6	Black	106TA9726
8	Black	106TA9727
10	Black	106TA9728
12	Black	106TA9729
14	Black	106TA9730
25	Black	106TA9731
30	Black	123TA5452

HEAT SHRINK TUBING

CRIMP SEALS (FOR WATERPROOF CONNECTIONS)



Size (mm ²)	D Before crimping (mm)	d After crimping (mm)	Colour	REF / 100 pieces
0.5-1.5	4.5	1.4	red	124TA2760
1.5-2.5	5.5	1.8	blue	124TA2761
4-6	6.8	2.2	yellow	124TA2762

EXPANDABLE TUBING



D Before expanding (mm)	d After expanding (mm)	Colour	REF / metre
6	12	Black	106TA9737
8	16	Black	106TA9738
10	20	Black	106TA9739
12	24	Black	106TA9740
15	27	Black	106TA9741
19	32	Black	106TA9742
28	47	Black	106TA9743



SPIRAL TUBING

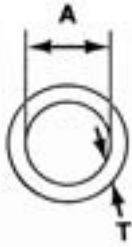

For use with cable Ø (mm)	A (mm)	T (thickness) (mm)	Colour	REF / metre
5 - 20	4,0	1,0	Black	106TA9750
10 - 40	9,0	1,5	Black	106TA9751
25 - 100	19,0	1,5	Black	106TA9752

LOOM TUBING

CORRUGATED LOOM TUBING (OPEN VERSION)



Inner ø (mm)	Outer ø (mm)	Colour	REF / metre	Tool
6.7	9.9	Black	106TA9744	123TA8032
8.9	12.7	Black	106TA9745	123TA8032
10.5	14.1	Black	112TA4814	123TA8032
12.8	17.0	Black	106TA9746	123TA8032
16.9	21.1	Black	106TA9747	123TA8033
23.2	27.7	Black	106TA9748	123TA8033
32.8	38.1	Black	106TA9749	-



CORRUGATED LOOM TUBING (CLOSED VERSION)



Inner ø (mm)	Outer ø (mm)	Colour	REF / metre
5.0	7.1	Black	123TA5436
6.5	10.0	Black	123TA7711
9.6	13.0	Black	123TA7712
11.8	15.8	Black	123TA7713
14.2	18.6	Black	123TA7714
21.7	28.5	Black	123TA7715



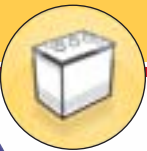

CABLE TIE BASES (WITHOUT CABLE TIE)

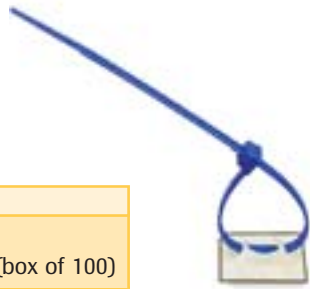

Dimensions 28 x 28 mm
REF 106TA9776
 cable tie bases : white (box of 100)
REF 106TA9777
 cable tie bases : black (box of 100)

REUSABLE CABLE TIE



packaging qty.: 100pcs.

width	length	REF white	REF black
9mm	187mm	123TA5445	123TA5447
9mm	344mm	123TA5446	123TA5448

CABLE TIES

Width (mm)	Length (mm)	REF Packaging quant.		Packaging quant.
		White	Black	
2,5	98	111TA3872	111TA3884	100 pieces
3,6	140	111TA3873	111TA3885	100 pieces
4,5	160	111TA3874	111TA3886	100 pieces
4,8	200	111TA3875	111TA3887	100 pieces
4,8	280	111TA3876	111TA3888	100 pieces
4,8	360	111TA3877	111TA3889	100 pieces
4,8	178	111TA3878	111TA3890	100 pieces
7,8	360	111TA3879	111TA3891	100 pieces
7,8	540	111TA3880	111TA3892	100 pieces
12,6	500	111TA3881	111TA3893	50 pieces
12,6	730	111TA3882	111TA3894	50 pieces
12,6	1000	111TA3883	111TA3895	50 pieces

Temperature resistant: -40 up to +80°C / Melting point: +250 °C
 Resistant against: oil, petrol, seawater, solvents, mold, and diluted light organic acids, alkalines.



CABLE TIE CUTTING TOOL



REF 111TA3896
 2,2 - 4,8 mm

REF 111TA3897
 4,8 - 7,8 mm

INSULATION TAPE



REF 106TA9753
 Red insulation tape
 25 m x 15 mm x 0.15 mm thick

REF 106TA9754
 Black insulation tape
 25 m x 15 mm x 0.15 mm thick

INSULATION TAPE



Each ref. contains 10 rolls of tape of 10m each

- BLACK** REF 107TA7668
- RED** REF 106TA9772
- BLUE** REF 106TA9773
- GREEN** REF 106TA9774

- YELLOW** REF 106TA9768
- WHITE** REF 106TA9769
- GREY** REF 106TA9770
- BROWN** REF 106TA9771

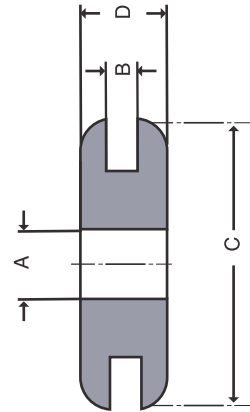

REF 106TA9775
 Set of 10 insulation sealing tape rolls in different colours.

**Specification:**

- Flexible PVC grommets for round cables
- Maximum temperature 50° C
- Flameproof in conformity with UL 94-HB

REF Black	Cable Diameter (mm)	Hole Diameter (mm)	Max. Plate Thickness	Other Dimensions	
		(A)		(B)	(C)
106TA9778	4,0	9,0	1,0	11,0	6,0
106TA9779	4,5	6,5	1,2	9,5	6,0
106TA9780	4,8	8,0	1,5	14,0	6,0
106TA9781	5,0	8,0	1,0	12,0	7,5
106TA9782	5,0	8,0	1,5	11,0	6,0
106TA9783	6,0	8,0	1,0	11,5	6,0
106TA9784	6,0	10,0	1,0	13,0	7,0
106TA9785	6,0	9,0	1,5	11,5	6,0
106TA9786	6,0	9,8	2,0	12,7	8,0
106TA9787	8,0	14,0	1,0	18,0	6,0
106TA9788	8,0	10,0	1,5	14,0	5,5
106TA9789	8,0	10,0	1,5	14,0	8,0
106TA9790	9,0	11,0	1,0	16,0	6,5
106TA9791	9,0	12,0	1,0	16,0	6,5
106TA9792	9,0	12,0	1,5	16,0	6,5
106TA9793	10,0	13,0	1,0	18,0	6,0
106TA9794	10,0	12,0	1,2	18,0	8,0
106TA9795	10,0	13,0	1,5	18,0	6,0
106TA9796	10,0	12,0	2,0	17,5	7,0
106TA9797	10,0	13,0	3,0	18,0	8,0
106TA9798	10,0	12,0	4,0	18,0	11,0
106TA9799	12,0	15,0	1,5	20,0	7,0
106TA9800	12,0	15,0	2,0	20,0	7,0



battery connector info chart

Type	Cable	Yellow 12V	Orange 18V	Red 24V	Grey 36V	Blue 48V	Green 72V	Black 80V	Brown 96V	Violet 120V
SB50	16 mm ²	—	—	106TA9801	105TA4671	—	—	106TA9804	—	—
SB175	50 mm ²	105TA4672	105TA4673	106TA9805	105TA4674	106TA9806	—	—	—	—
SB350	70 mm ²	105TA4675	106TA9807	106TA9808	106TA9809	106TA9810	106TA9811	—	—	—

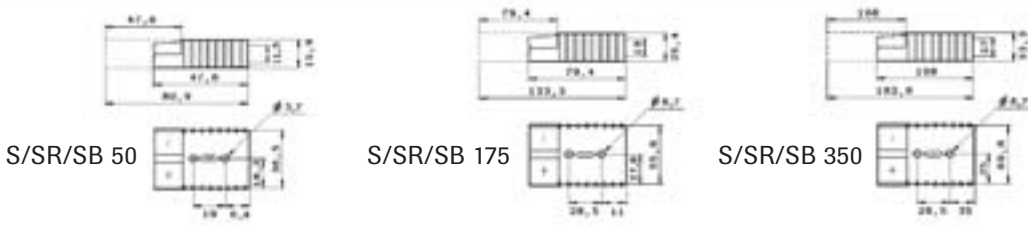

SBE160	35 mm ²	105TA4676	106TA9812	106TA9813	106TA9814	105TA4677	106TA9815	106TA9816	—	—
SBX175	50 mm ²	106TA9817	106TA9818	106TA9819	106TA9820	106TA9821	106TA9822	106TA9823	—	—
SBE320	70 mm ²	106TA9831	106TA9832	106TA9833	107TA8404	106TA9834	106TA9835	106TA9836	106TA9837	106TA9838
SBX350	70 mm ²	106TA9824	106TA9825	106TA9826	106TA9827	106TA9828	106TA9829	106TA9830	—	—

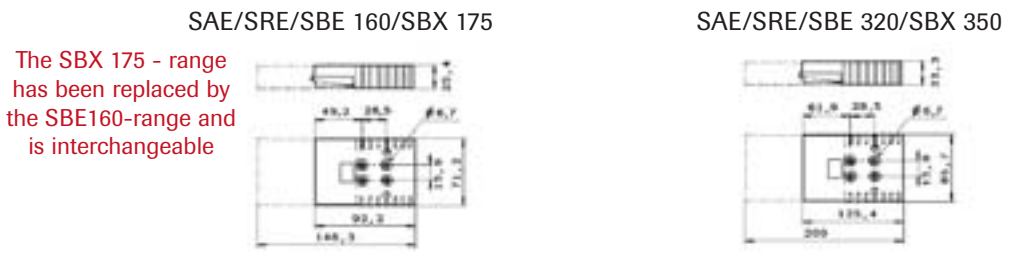

All battery connectors are supplied as housing and contacts (no auxiliary contacts)



COMPLETE CONNECTORS (HOUSING + CONTACTS)

SB / S 50



Type	Colour	Wire size	REF
SB / S 50	Red	4/6 mm ²	105TA4670
		16 mm ²	106TA9801
	Grey	4/6 mm ²	106TA9802
		16 mm ²	105TA4671
	Black	4/6 mm ²	106TA9803
		16 mm ²	106TA9804

SB / S 175



SB / S 175	Yellow	50 mm ²	105TA4672
	Orange	50 mm ²	105TA4673
	Red	50 mm ²	106TA9805
	Grey	50 mm ²	105TA4674
	Blue	50 mm ²	106TA9806

SB / S 350



SB / S 350	Yellow	70 mm ²	105TA4675
	Orange	70 mm ²	106TA9807
	Red	70 mm ²	106TA9808
	Grey	70 mm ²	106TA9809
	Blue	70 mm ²	106TA9810
	Green	70 mm ²	106TA9811

SBE / SAE 160 - SBX / SA 175



SBE / SAE 160 - SBX / SA 175	Yellow	35 mm ²	105TA4676
	Orange	35 mm ²	106TA9812
	Red	35 mm ²	106TA9813
	Grey	35 mm ²	106TA9814
	Blue	35 mm ²	105TA4677
	Green	35 mm ²	106TA9815
	Black	35 mm ²	106TA9816
	Yellow	50 mm ²	106TA9817
	Orange	50 mm ²	106TA9818
	Red	50 mm ²	106TA9819
Grey	50 mm ²	106TA9820	
Blue	50 mm ²	106TA9821	
Green	50 mm ²	106TA9822	
Black	50 mm ²	106TA9823	

The SBX / SA 175 connectors are replaced and interchangeable with SBE / SAE 160



COMPLETE CONNECTORS (HOUSING + CONTACTS)

SBX / SA 350



Type	Colour	Wire size	REF
SBX / SA 350	Yellow	70 mm ²	106TA9824
	Orange	70 mm ²	106TA9825
	Red	70 mm ²	106TA9826
	Grey	70 mm ²	106TA9827
	Blue	70 mm ²	106TA9828
	Green	70 mm ²	106TA9829
	Black	70 mm ²	106TA9830

SBE / SAE 320



Type	Colour	Wire size	REF
SBE / SAE 320	Yellow	70 mm ²	106TA9831
	Orange	70 mm ²	106TA9832
	Red	70 mm ²	106TA9833
	Grey	70 mm ²	107TA8404
	Blue	70 mm ²	106TA9834
	Green	70 mm ²	106TA9835
	Black	70 mm ²	106TA9836
	Brown	70 mm ²	106TA9837
	Violet	70 mm ²	106TA9838

CONTACT SET (2 PCS)



Contact set: (2 pcs.)

for use with	Wire size	REF
SB / S 50	4/6 mm ²	123TA7585
	16 mm ²	106TA9839
SB / S 175	50 mm ²	106TA9840
	SBE / SAE 160 - SBX / SA 175	
SB / S 350	35 mm ²	106TA9841
	50 mm ²	106TA9842
SBX / SA 350 - SBE / SAE 320	70 mm ²	106TA9843
	35 mm ²	106TA9845
	50 mm ²	106TA9846
	70 mm ²	106TA9847
	107 mm ²	106TA9848



3-POLE CONNECTOR SB 3175



3-Pole connectors

Complete connector (housing + contacts)

Type	Colour	Wire size	REF
SB 3175	Grey	50 mm ²	106TA9849

<u>Contact set (3 pieces)</u>	Wire size	REF
	50 mm ²	107TA8405

3-POLE CONNECTOR SBE 3160 + HANDLE



3-Pole connectors

Complete connector (housing + contacts)

Fig	Type	Colour	Wire size	REF
1	SBE 3160	Red	50 mm ²	106TA9850
2	SBE 3160	Blue	50 mm ²	105TA4678

<u>Contact set (3 pieces)</u>	Wire size	REF
	50 mm ²	107TA8406

Handle for SBE 3160

3	Black	105TA4679
---	-------	-----------

EXTRACTION TOOLS



Extraction tools

Fig	for use with	REF
4	SBE 160 / SBX 175	107TA8407
5	SB 350 / SBX 350 / SBE 320	107TA8408
6	Aux. contacts & power pole contacts	107TA8409

DUST COVERS



REF	colour	connectors
123TA7586	black	350AMP
107TA8412	red	350AMP
107TA8410	red	50AMP
123TA7587	black	50AMP



DUST COVERS



REF	colour	connectors
123TA7588	black	175AMP
123TA7589	black	350AMP



AUXILIARY CONTACT KIT FOR SBE / SBX



Auxiliary contact kit for SBE / SBX:

Wire size AWG	Wire size mm ²	REF
18 TO 12	1 TO 4	107TA8413

NYLON HANDLE



Nylon handle:

for use with	Colour	REF
SB50	red	107TA8414
	black	107TA8415

NYLON HANDLE



Nylon handle:

for use with	Colour	REF
SB / SBX 175 - SB / SBX 350 - SBE 160 - SBE 320	grey	116TA5895
	red	116TA5896

STEEL HANDLE



Steel handle:

for use with	Colour	REF
SB / SBX 175 - SB / SBX 350 - SBE 160 - SBE 320	red	107TA8420



SPECIAL HANDLES FOR BT



Special handles for BT:

for use with	Fig.	Colour	REF
SBE 160 / SBX 175	1	Black	106TA9851
	2	Black	106TA9852

MANUAL RELEASES

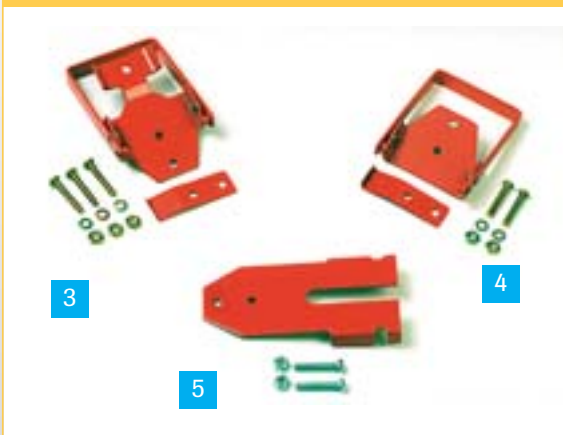

Manual releases:

for use with	Fig.	Description	Destination	REF
SB 175	4	Locking half	battery	106TA9853
	5	Mounting half	truck/charger	106TA9854
SB 350	4	Locking half	battery	106TA9855
	3	Locking half (with lockout spring)	battery	106TA9856
	5	Mounting half	truck/charger	106TA9857
SBE 160 / SBX 175	6	Locking half	truck/charger	106TA9858
	7	Mounting half	battery	106TA9859
SBE 320 / SBX 350	6	Locking half	truck/charger	106TA9860
	7	Mounting half	battery	106TA9861

MANUAL RELEASES

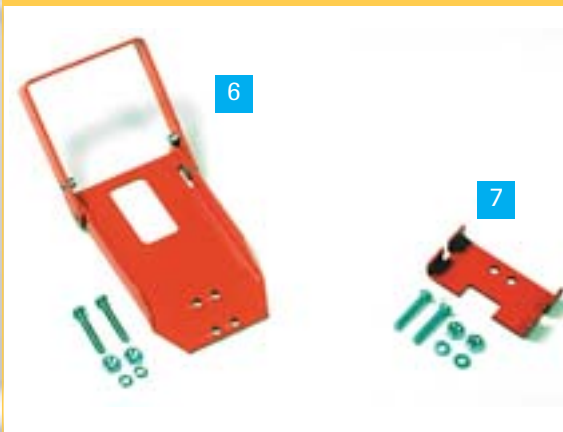

AIR SUPPLY SYSTEM



Air supply system:

for use with	REF
SBE 160 / 320	123TA7590

NEW IN
PROGRAM



CABLE CLAMPS

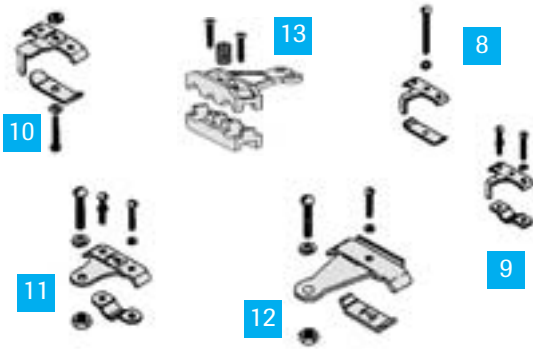

Cable clamps:

for use with	Fig.	Description	REF
SB 50	8	2 single conductors	106TA9862
	9	1 twin conductor	106TA9863
SB 175	10	2 single conductors	106TA9864
	11	1 twin conductor	106TA9865
SB 350	12	2 single conductors	106TA9866
SBE 160 / SBX 175 / SBE 320 / SBX 350	13	2 single conductors	106TA9867
SBE 160 / SBX 175	no pic.	2 single conductors	107TA8422
SBE 320 / SBX 350	no pic.	2 single conductors	107TA8423

REDUCING BUSHES



Reducing bushing:

Wire size mm ²	Wire size AWG	REF
16 to 10	6 to 8	106TA9868
16 to 6/4	6 to 10/12	106TA9869
16 to 2/1	6 to 14/16	106TA9870
25 to 10		112TA4815
25 to 16		112TA4816
35 to 25	2 to 4	106TA9875
35 to 16	2 to 6	106TA9876
35 to 10	2 to 8	106TA9877
50 to 40	1/0 to 1	106TA9871
50 to 35	1/0 to 2	106TA9872
50 to 25	1/0 to 4	106TA9873
50 to 16	1/0 to 6	106TA9874
70 to 50	2/0 to 1/0	106TA9878



CODING PIN



1



2



3

Coding pin:

for use with: SBE 160 / 320 - SBX 175 / 350

Fig.	Type	Colour	REF
1	charger key	yellow	106TA9879
2	truck/charger 16/12 AWG - 1/4 mm ²	green	106TA9880
3	battery 16/12 AWG - 1/4 mm ²	green	106TA9881

ACCESSORIES FOR BATTERY CONNECTORS

CONNECTOR LOCKOUTS

175 & 350-AMP
CONNECTOR LOCKOUTS

For use with 175AMP or 350AMP connectors.
Lock not included.

SB350 - LOCKOUT
REF 115TA4599



SB175 - LOCKOUT
REF 115TA4598

Special order quantity discount for all connectors



POWERPOLE MODULAR CONNECTORS

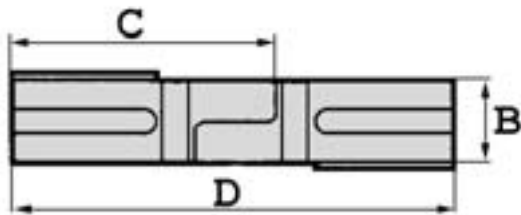
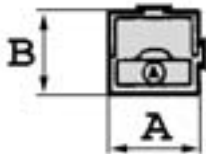

Current rating	A	B	C	D
15 A	7,9	7,9	24,6	41,3
30 A	7,9	7,9	24,6	41,3
75 A	15,9	15,9	47,6	81,4
120 A	22,2	22,2	69,9	117,5
180 A	28,6	28,6	82,6	139,7

(dimensions in mm)

Powerpole modular connectors:

PP 15A : Complete connector (housing + contact)

Housing colour	Wire size AWG	Wire size mm ²	REF
Red	16/20	1,5/0,5	106TA9882
Black	16/20	1,5/0,5	106TA9883
White	16/20	1,5/0,5	106TA9884
Blue	16/20	1,5/0,5	106TA9885
Contact	16/20	1,5/0,5	106TA9886

PP 30A : Complete connector (housing + contact)

Housing colour	Wire size AWG	Wire size mm ²	REF
Red	12/16	4 / 1,5	106TA9887
Black	12/16	4 / 1,5	106TA9888
White	12/16	4 / 1,5	106TA9889
Blue	12/16	4 / 1,5	105TA4691
Contact	12/16	4 / 1,5	106TA9890

PP 75A : Complete connector (housing + contact)

Housing colour	Wire size AWG	Wire size mm ²	REF
Red	6	16	106TA9891
Black	6	16	105TA4692
Blue	6	16	106TA9892
Green	6	16	106TA9893
Contact	6 10/12	16 6 / 4	106TA9894 106TA9895

PP 120A : Complete connector (housing + contact)

Housing colour	Wire size AWG	Wire size mm ²	REF
Red	2	35	112TA4817
Blue	2	35	106TA9896
White	2	35	105TA4693
Contact	2 4 6	35 25 16	106TA9897 106TA9898 106TA9899

PP 180A : Complete connector (housing + contact)

Housing colour	Wire size AWG	Wire size mm ²	REF
Blue	1 / 0	50	106TA9900
Red	1 / 0	50	106TA9901
Contact	1 / 0 2 4	50 35 25	106TA9902 106TA9903 106TA9904