

*This is only a selection.
For all other hoods
please call us!*

HOOD & CHASSIS PARTS

USED FOR ATLET

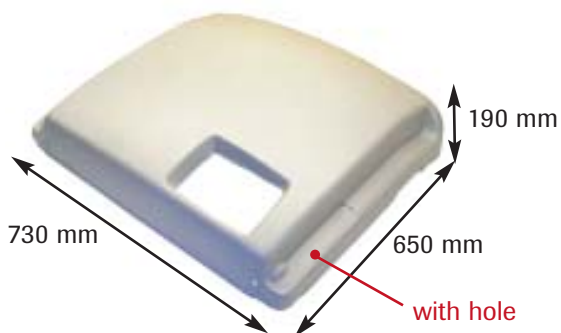

REF 122TA7488
Type: TLL/TLP

Colour: white

USED FOR ATLET

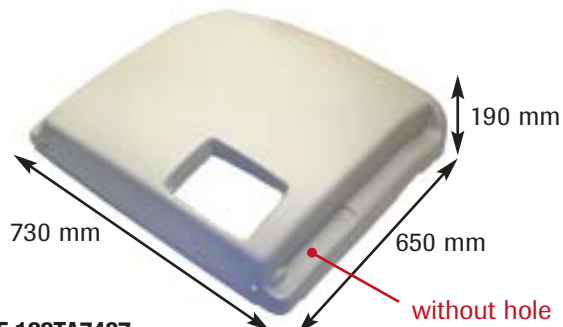

REF 122TA7487
Type: TLL/TLP

Colour: white

USED FOR ATLET

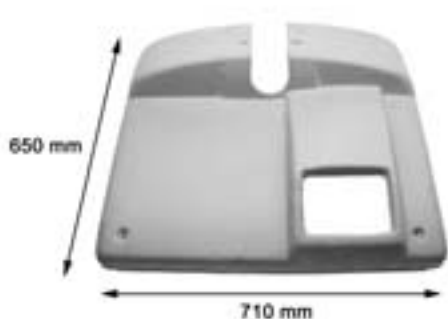

REF 107TA4884
Type: TLL

Colour: grey

USED FOR AMEISE-JUNGHEINRICH



REF 107TA4880
Type: ECE20 / 812 / 93

Colour: grey

USED FOR AMEISE-JUNGHEINRICH

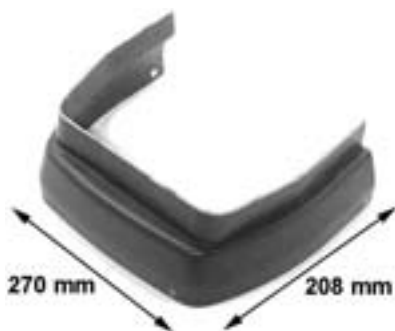

REF 107TA4883
Type: ECE20 / 812 / 93

Colour: grey

USED FOR AMEISE-JUNGHEINRICH

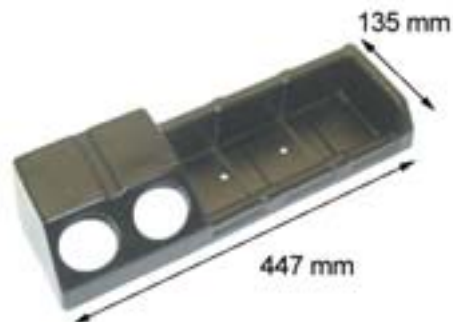

REF 107TA4877
Type: ERE / ERC

Colour: black

USED FOR BT



REF 107TA4878
Type: LSV 1000E / 10

Colour: black

USED FOR BT

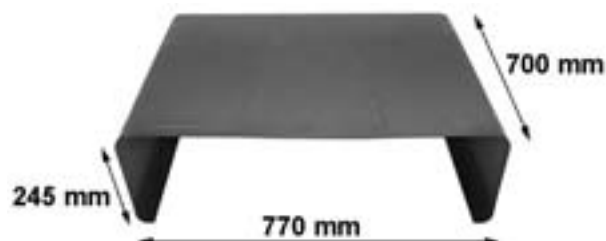

REF 107TA4879
Type: BT LIFTER SV / VB

Colour: black



HOODS

USED FOR BT



REF 107TA4892

LSF - LSV - E11 - LST

Colour: black

USED FOR BT



REF 107TA4881

LSF - LSV - E10 - LST

Colour: black

USED FOR BT



REF 107TA4891

LT 2000-11

Colour: black

USED FOR BT



REF 107TA4886

LT2000-10

Colour: black

USED FOR BT

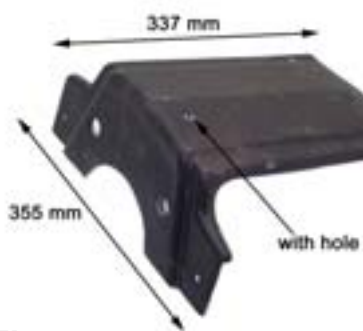

REF 107TA4889

Type: LT 2000/10

Colour: black

USED FOR BT

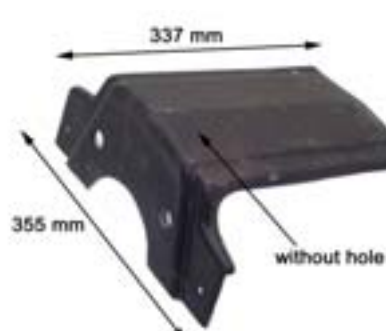

REF 107TA4882

Type: LT 2000/10

Colour: black

USED FOR BT



REF 107TA4885

Type: RT1350-2000

Plexi protection panel

Colour: transparent

USED FOR BT

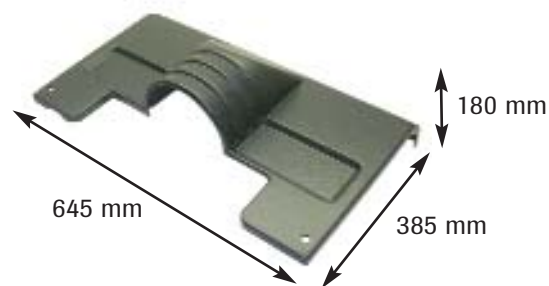

REF 122TA7520

Type: TL16

Colour: black

USED FOR BT

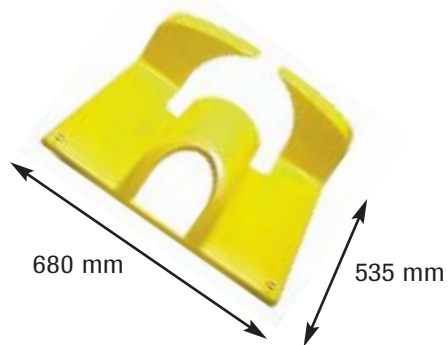

REF 122TA7519
Type: ELE 16-18-20 Colour: yellow

USED FOR BT

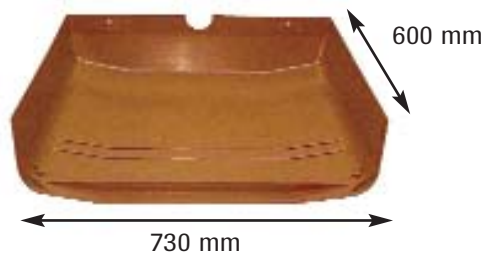

REF 122TA7518
Type: OS1.0-2.0-3.0, OMC, OMCW Colour: red

USED FOR BT

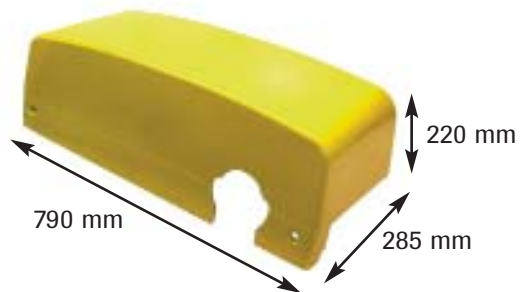

REF 122TA7521
Colour: yellow

USED FOR CLARK

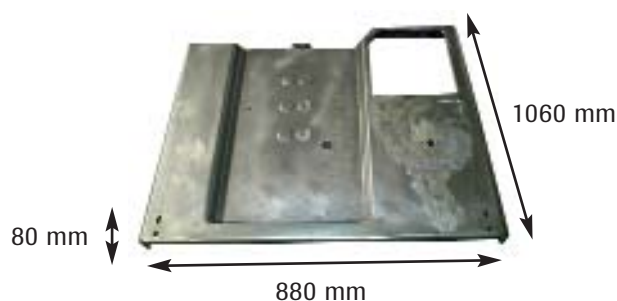

REF 122TA7537
Type: S20, S25, S30, CEM-MEG 375 Colour: green

USED FOR CLARK

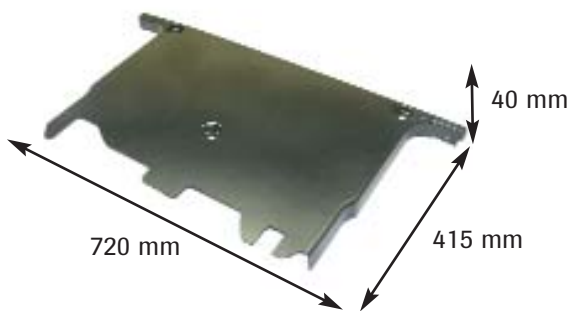

REF 122TA7489
Type: CDP20-30H Colour: black

USED FOR CLARK

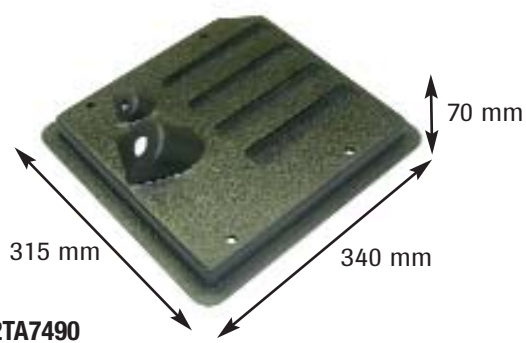

REF 122TA7490
Type: DPM-GPM 12-20S/20-30 second model Colour: orange

USED FOR CLARK

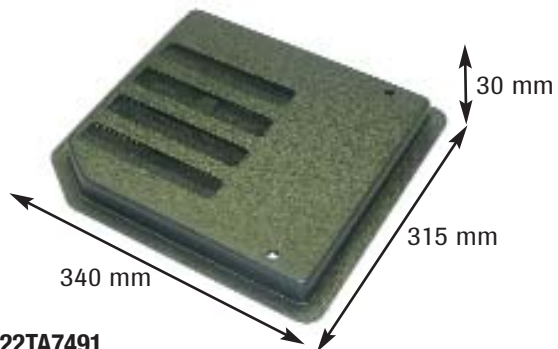

REF 122TA7491
Type: DPM-GPM 15-17/20-30 first model Colour: black

USED FOR CLARK



REF 122TA7492
Type: DPM-GPM 12-20S/20-30 second model Colour: black



HOODS

USED FOR CROWN

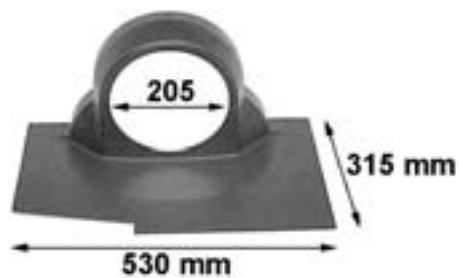

REF 107TA4890
Type: GPW1000

Colour: black

USED FOR CROWN



REF 107TA4887
GPW 1000

Colour: black

USED FOR CROWN

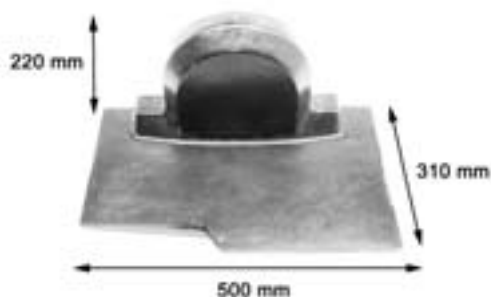

REF 107TA4899
Type: GPW

Colour: black

USED FOR CROWN

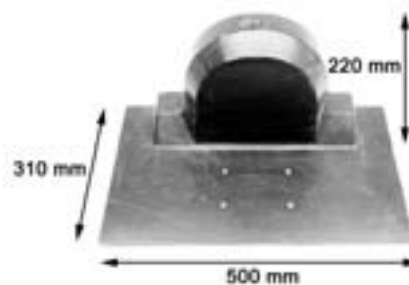

REF 107TA4898
Type: GPW

Colour: black

USED FOR CROWN

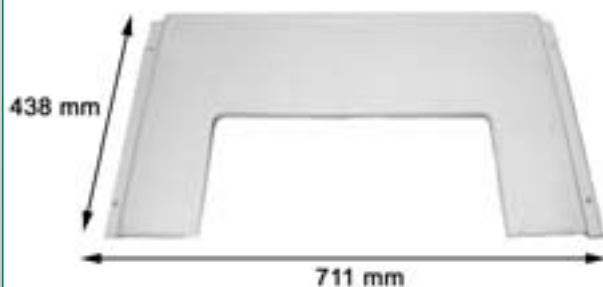

REF 107TA4888
Type: GPW

Colour: white

USED FOR FIAT - OM

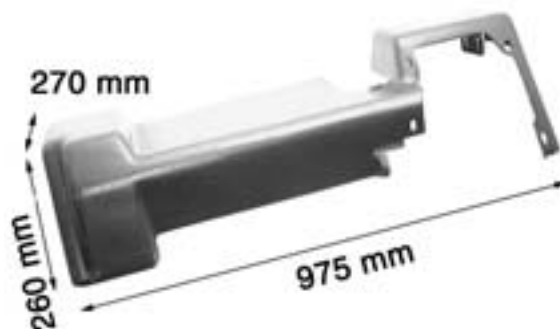

REF 107TA4900
EU3/15 - EU15

Colour: grey

USED FOR JUNGHEINRICH

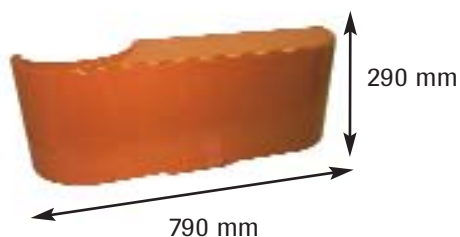

REF 122TA7535
Type: WP 10-12-14-16

Colour: orange

USED FOR JUNGHEINRICH

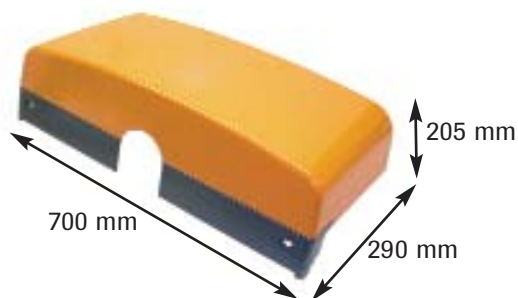

REF 122TA7536
Type: A16

Colour: orange

USED FOR JUNGHEINRICH

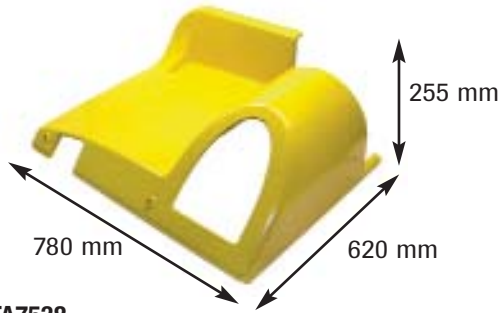

REF 122TA7538
Type: EJC 14

Colour: yellow

USED FOR JUNGHEINRICH

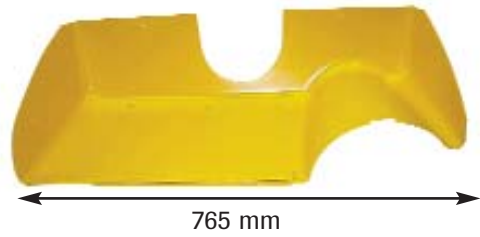

REF 122TA7522

Type: EMC 10/22, EMB 10/22

Colour: yellow

USED FOR JUNGHEINRICH

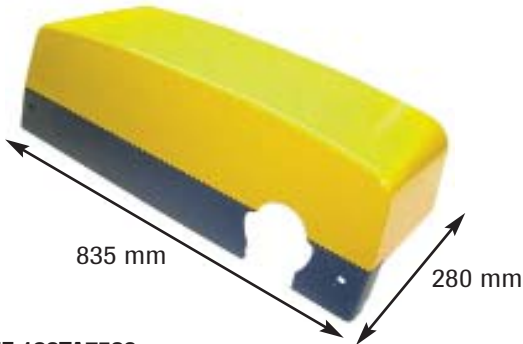

REF 122TA7523
Type: WP14-16

Colour: yellow

USED FOR LAFIS



REF 112TA4943

Colour: black

USED FOR LAFIS

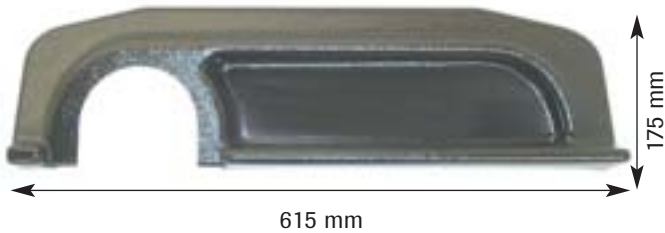

REF 112TA4942

Colour: dark brown

USED FOR LINDE

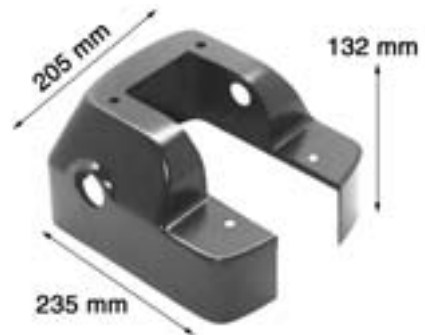

REF 107TA4901

type: N20 - N20H

Colour: black

USED FOR LINDE

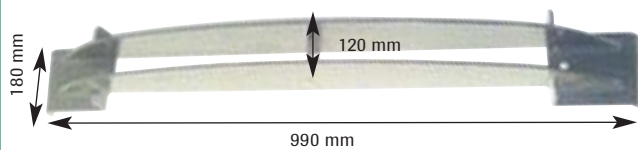

REF 107TA4949

Used on H25D-02 series 351
Made of metal

USED FOR LINDE

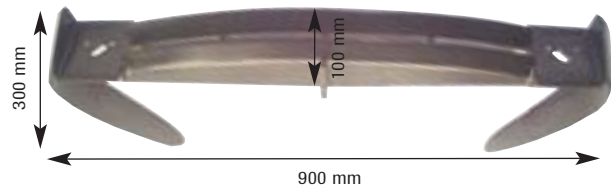

REF 105TA4768

Used on H25D series 351
Made of rubber



HOODS

USED FOR LINDE



REF 107TA4907

Type: E12/15/16 - series 324
valve cover

Colour: black

USED FOR LINDE

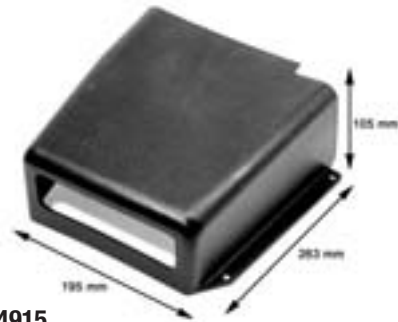

REF 107TA4915

Type: E15Z / E16P - E18P / E18Z series 322
valve cover

Colour: black

USED FOR LINDE



REF 107TA4894

Type: E25 - series 325
old type

Colour: grey

USED FOR LINDE - FENWICK



REF 107TA4922

Type: XA16 / XA20

Colour: black

USED FOR LINDE / FENWICK

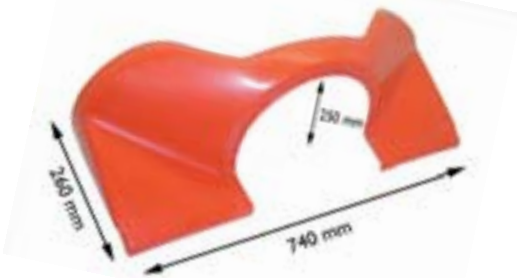

REF 107TA4913

Type: T16 - XA 16/20 - 361 Hand pallet truck

Colour: red

USED FOR LINDE / FENWICK



REF 107TA4911

Type: N20 - N20H - Series: 377

Colour: grey

USED FOR LINDE / FENWICK

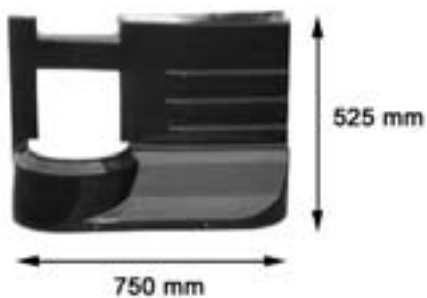

REF 107TA4912

Type: L10 - L12 - Series 364 (1993)

Colour: black

USED FOR LINDE / FENWICK



REF 107TA4909

Type: XG 10 - XG 12

Colour: black

USED FOR LINDE / FENWICK

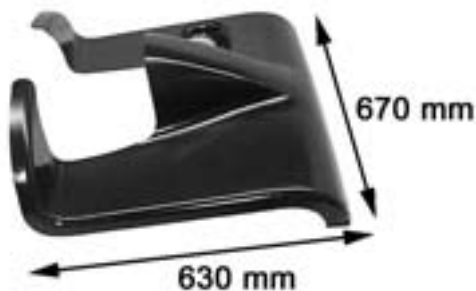

REF 107TA4924 Metal
Type: T16 - T18 - T20 series 360 Colour: grey

USED FOR LINDE

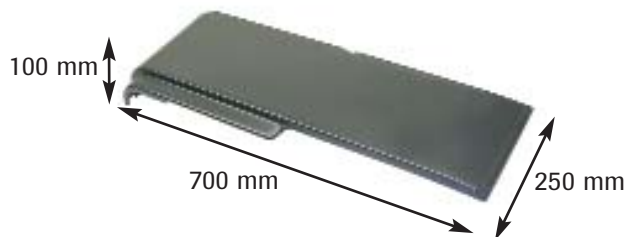

REF 122TA7524
Type: R14/376 Colour: grey

USED FOR LINDE

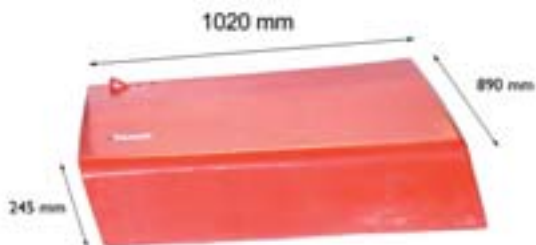

REF 107TA4895
Type: H60D - series 320 right-hand side Colour: red

USED FOR LINDE



REF 107TA4893
Type: H60D - series 320 Left-hand side - seat side Colour: red

USED FOR LINDE

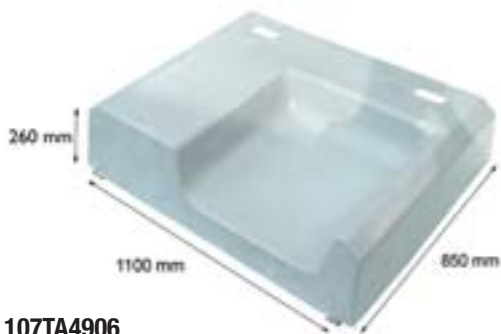

REF 107TA4906
Type: H25D - series 315 old type Colour: grey

USED FOR LINDE



REF 107TA4923
Type: L14/14AP-365 Colour: black

USED FOR LINDE



REF 107TA4908
Type: E15 - series 323 - old type Colour: grey

USED FOR LINDE

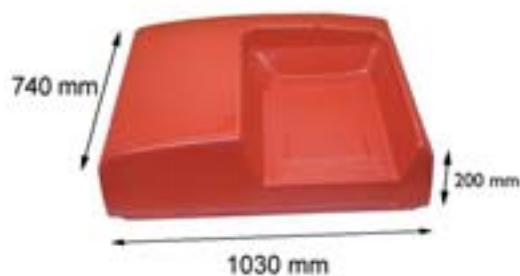

REF 107TA4905
Type: H15D - series 330 Colour: red



HOODS

USED FOR LINDE



REF 107TA4903

Type: E25 - Drive engine series 325 Colour: black

USED FOR LINDE



REF 107TA4904

Type: H40D - series 332

Colour: red

USED FOR LINDE

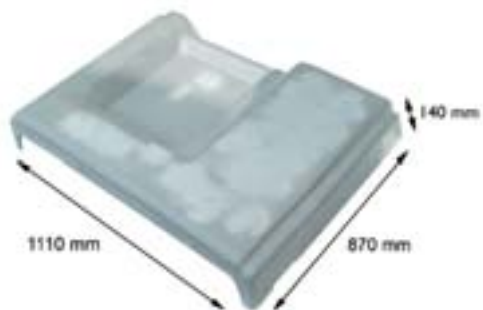

REF 107TA4902

Type: H25D - series 331

Colour: grey

USED FOR LINDE



REF 107TA4914

Type: E25 - series 325
New type, back hood

Colour: red

USED FOR LINDE



REF 107TA4916

Type: T20S - 142

Colour: black

USED FOR LINDE

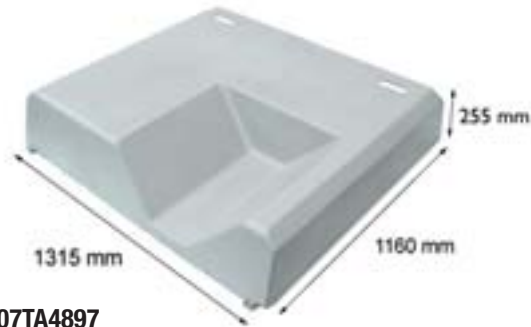

REF 107TA4897

Type: H40D - series 318
old type

Colour: grey

USED FOR LINDE

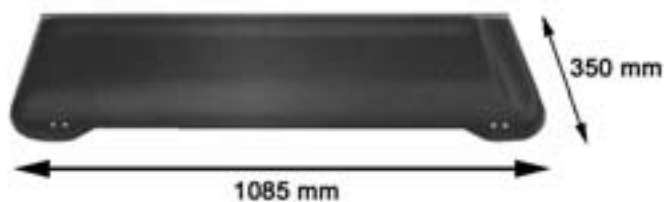

REF 107TA4896

Type: H35/40/45 - series 352
Polyester battery cover
Colour: grey

REF 124TA1085

Type: H35/40/45 - series 352
Metal battery cover
Colour: grey

USED FOR LINDE

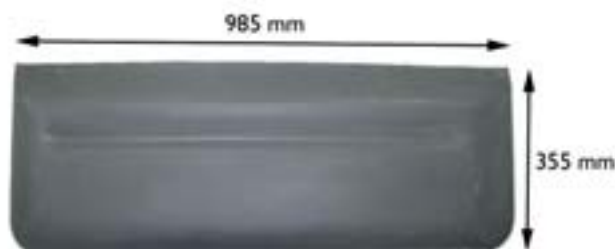

REF 107TA4910

Type: H20/25/30 - series 351
Polyester battery cover
Colour: grey

REF 124TA1086

Type: H20/25/30 - series 351
Metal battery cover
Colour: grey

USED FOR LOC

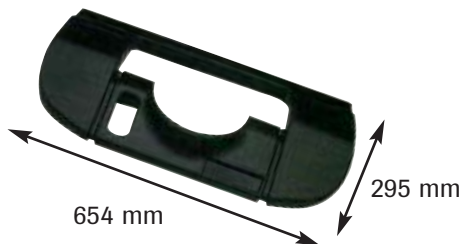

REF 122TA7532
Type: Microloc

Colour: black

USED FOR MIC

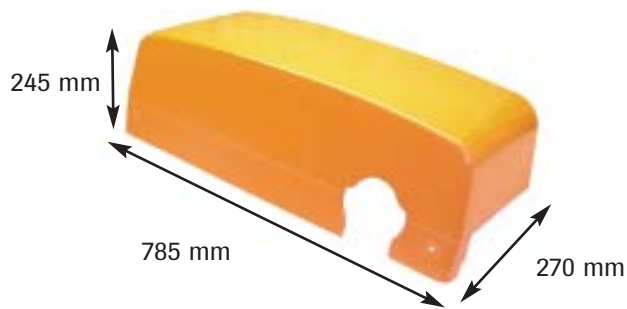

REF 122TA7486

Colour: orange

USED FOR MIC

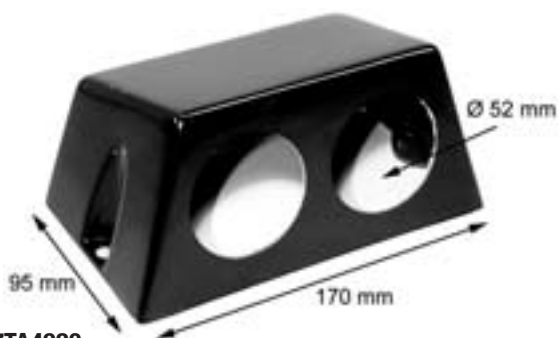

REF 107TA4920

Type: TEA1400 / TEA2000
EJE1400C - A160B / A140

Colour: black

USED FOR MIC

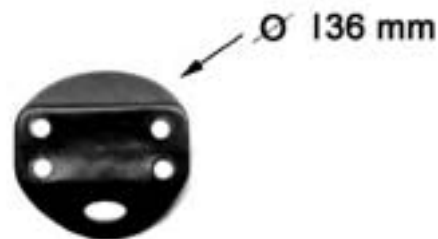

REF 107TA4921

Colour: black

USED FOR MIC

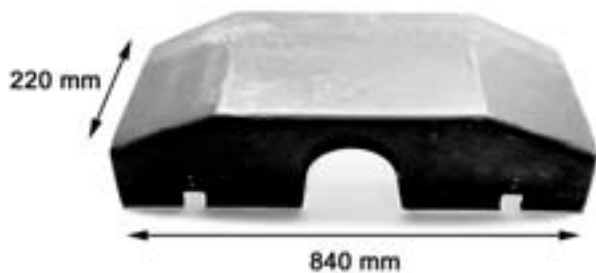

REF 107TA4919

Type: G 100 B

Colour: grey

USED FOR MIC

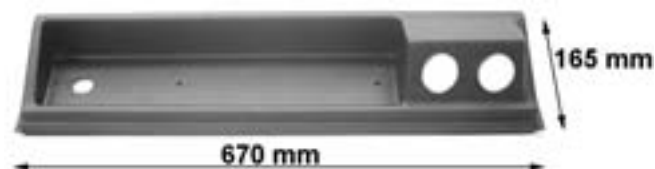

REF 107TA4917

Type: P200TEA2

Colour: black

USED FOR MIC / STEINBOCK



REF 122TA7484

Type: EFG-V/20, LE 13-20, KE 16-20

Colour: grey

USED FOR MIC / STEINBOCK - BOSS



REF 107TA4918

Type: KE16 / KE18 - LE16 / WM10

Colour: black

USED FOR NISSAN

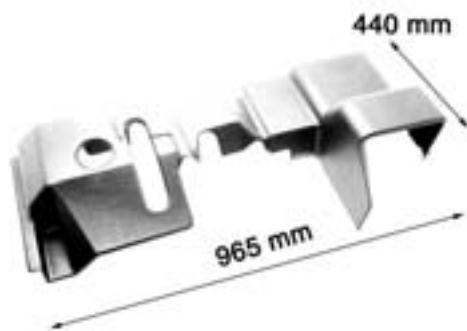

REF 107TA4925
Type: NO1(S)

Colour: black

USED FOR PIMESPO



REF 107TA4929
Type: CT-TS

Colour: black

USED FOR PIMESPO

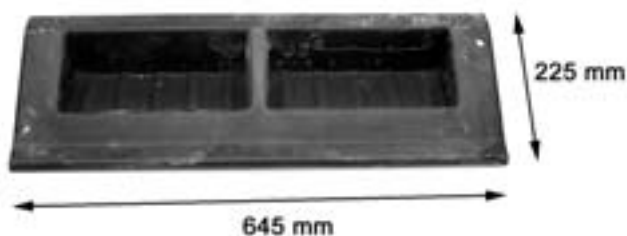

REF 107TA4928
Type: TS-C

Colour: black

USED FOR PIMESPO

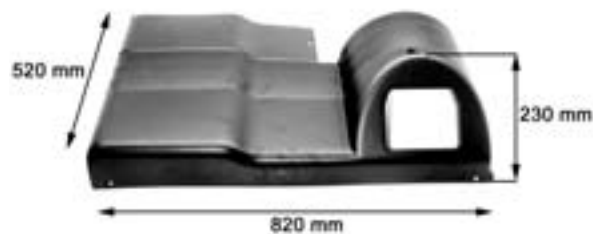

REF 107TA4927
Type: CN 13/16

Colour: black

USED FOR PIMESPO

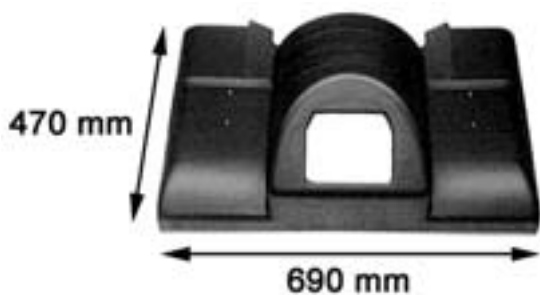

REF 107TA4930
Type: TN20

Colour: black

USED FOR PIMESPO

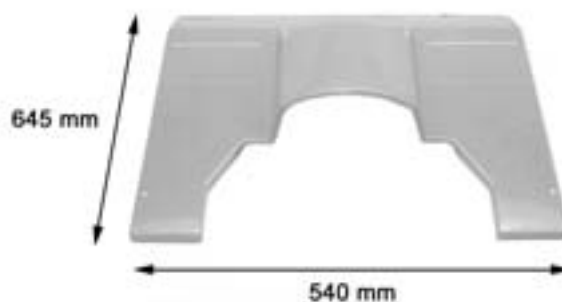

REF 107TA4926
Type: TS-C

Colour: orange

USED FOR STEINBOCK - BOSS

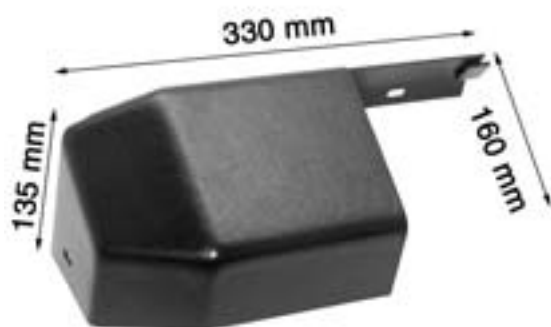

REF 107TA4932

Type: KE 16/KE 18 - LE 16/ WM 10 Colour: black

USED FOR STILL

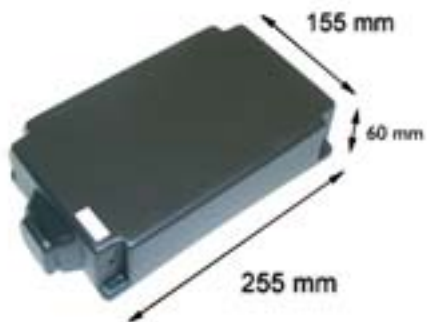

REF 107TA4940
Type: R50 - Power steering panel Colour: black

USED FOR STILL

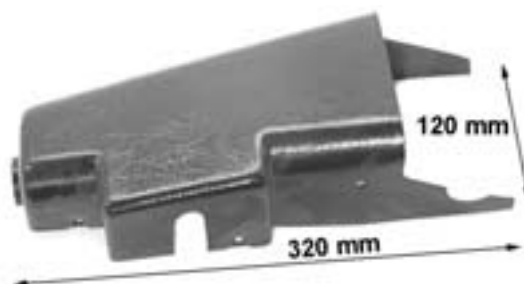

REF 107TA4936
Type: R50 Colour: black

USED FOR STILL

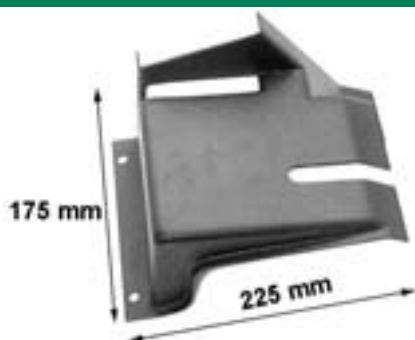

REF 107TA4939
Type: R50 Colour: black

USED FOR STILL

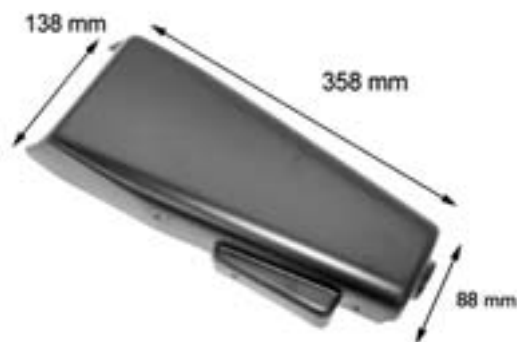

REF 107TA4931
Type: R50 Colour: black

USED FOR STILL



REF 107TA4934
Type: R50 Colour: black

USED FOR STILL

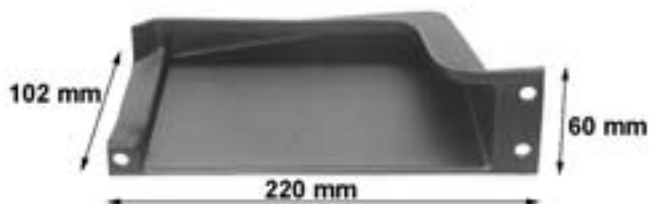

REF 107TA4933
Type: R50 Colour: black

USED FOR STILL

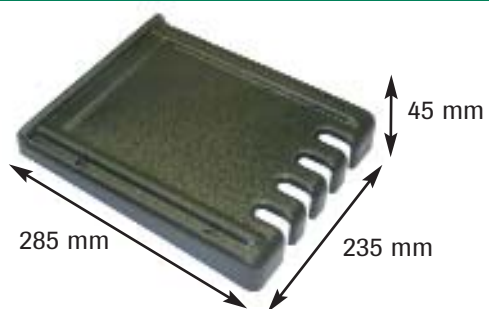

REF 122TA7517
Type: R50
valve cover Colour: black



HOODS

USED FOR STILL

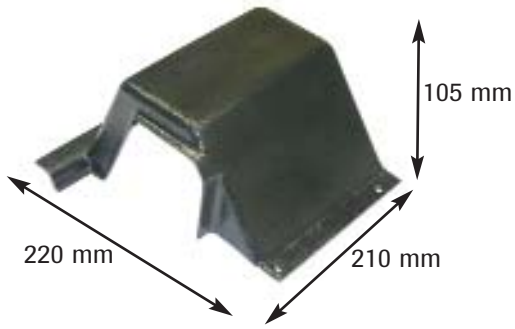

REF 122TA7530
Type: R60-25

Colour: black

USED FOR STILL

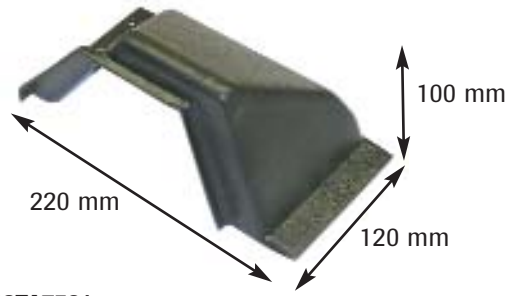

REF 122TA7531
Type: R60-25

Colour: black

USED FOR STILL

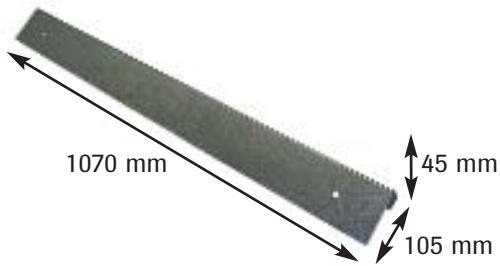

REF 122TA7526
Type: R60-25

Colour: black

USED FOR STILL

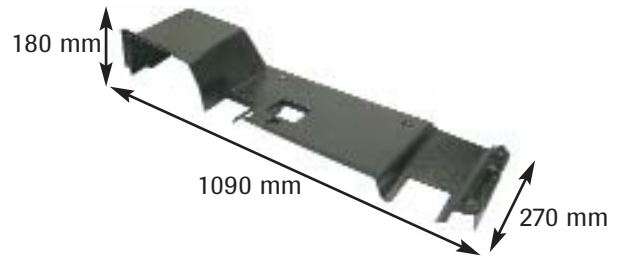

REF 122TA7525
Type: R60-25
valve cover

Colour: black

USED FOR STILL

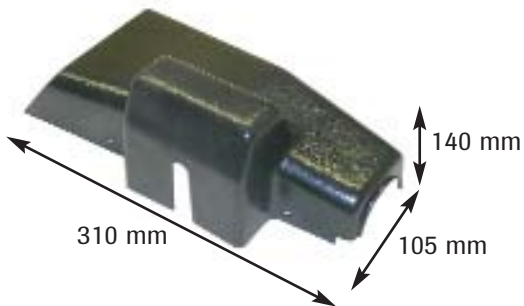

REF 122TA7528
Type: R60-25

Colour: black

USED FOR STILL

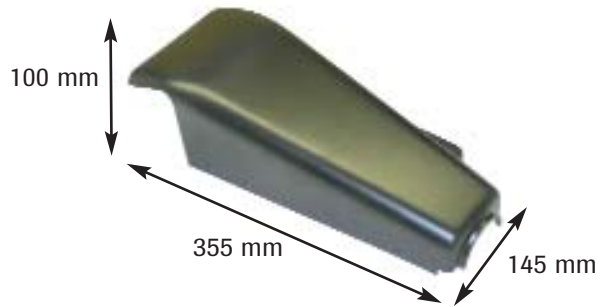

REF 122TA7527
Type: R60-25

Colour: black

USED FOR STILL

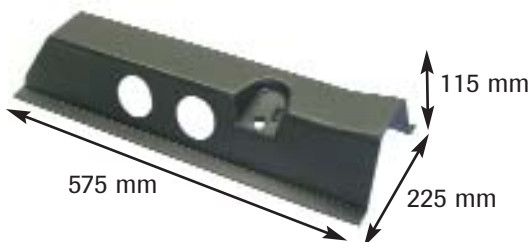

REF 122TA7529
Type: R60-25

Colour: black



HOODS

USED FOR STILL/WAGNER

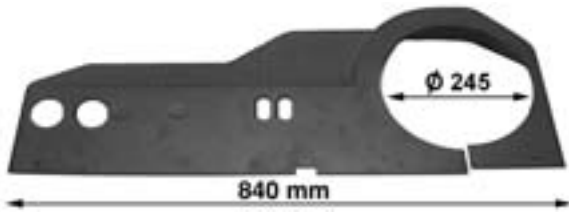

REF 107TA4946
Type: EGV

Colour: black

USED FOR STILL



REF 116TA4362

Colour: black

USED FOR STILL

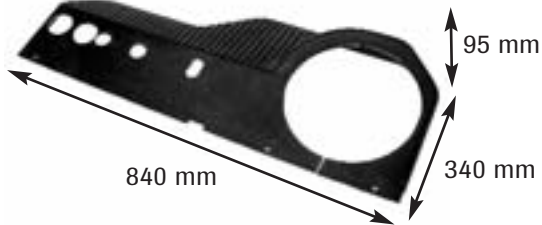

REF 122TA7534

Colour: black

USED FOR STILL / WAGNER



REF 107TA4937
Type: EGU 1250

Colour: black

USED FOR STILL

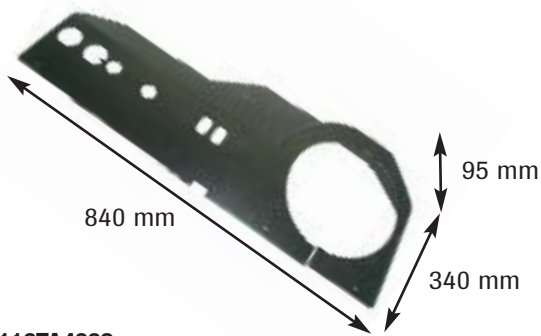

REF 116TA4362

Colour: black



HOODS

USED FOR STILL



REF 116TA4359
Type: R5041-44

Colour: black

USED FOR STILL



REF 122TA7485
Type: CS20

Colour: black

USED FOR STILL

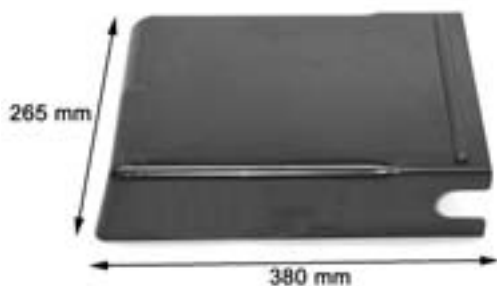

REF 107TA4935

Type: R70 - Logic unit

Colour: black

USED FOR STILL / WAGNER

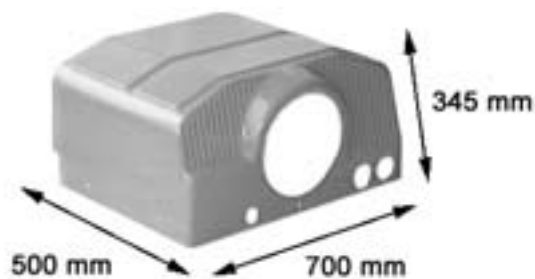

REF 107TA4938

Type: GFK

Colour: orange

USED FOR STILL / WAGNER



REF 107TA4945

Type: EGV 1250 - 1600 / 2000 (1983)

Colour: black

USED FOR STILL / WAGNER

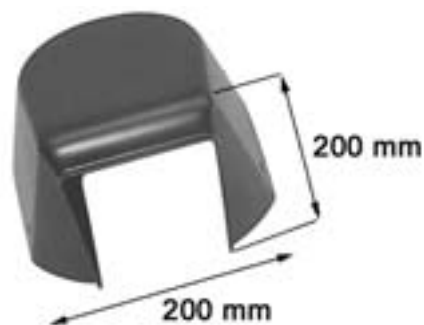

REF 107TA4942

Type: EGU 20 (1994)

Colour: black

USED FOR STILL / WAGNER



REF 107TA4948
Type: EGU 20

Colour: black

USED FOR STILL/WAGNER



REF 107TA4943
Type: EGU-16

Colour: black

USED FOR WAGNER



REF 122TA8991
Type: EGU

Colour: black

USED FOR STILL / WAGNER

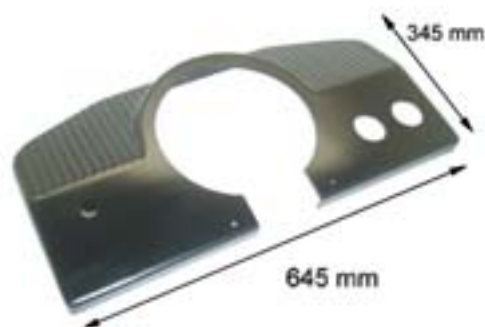

REF 107TA4941
Type: EGU 1600, 2000

Colour: black

USED FOR TOYOTA

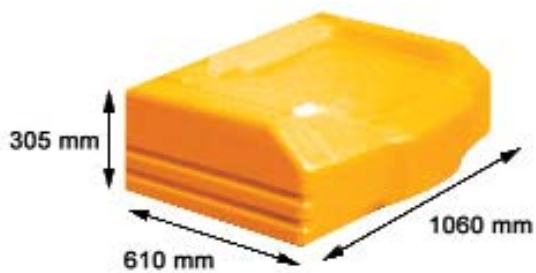

REF 107TA4947
Type: 2T & 3T - series 5

Colour: orange

USED FOR TOYOTA

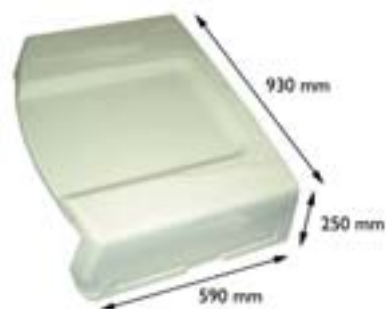

REF 107TA4944
Type: 2T & 3T - series 4

Colour: beige

USED FOR YALE



REF 122TA7533
Type: MS12

Colour: black



COVERS USED FOR TOYOTA 5FBE 15, 18, 20



SIDE CHASSIS COVERS

USED FOR TOYOTA



REF 106TA6386
type: 5FBE 15, 18, 20 - upper side cover, RH

USED FOR TOYOTA

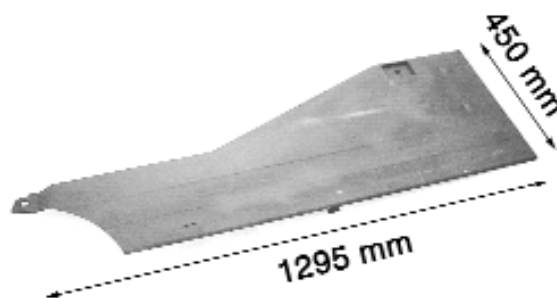

REF 106TA6384
type: 5FBE 15, 18, 20 - upper side cover, LH

USED FOR TOYOTA



REF 106TA6385
type: 5FBE 15, 18, 20 - lower side cover, RH

USED FOR TOYOTA

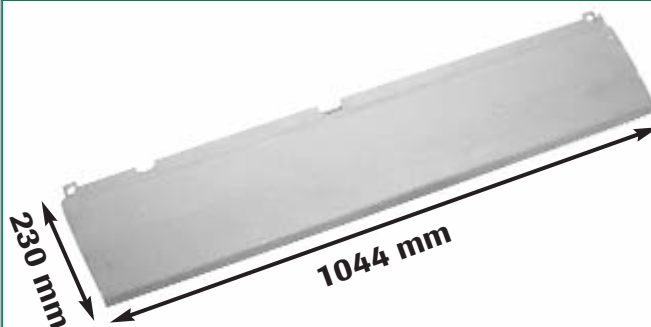

REF 106TA6387
type: 5FBE 15, 18, 20 - lower side cover, LH

USED FOR BRUNILIFT



REF 106TA7919

OUT OF PRODUCTION HOOD & CHASSIS PARTS

USED FOR FENWICK

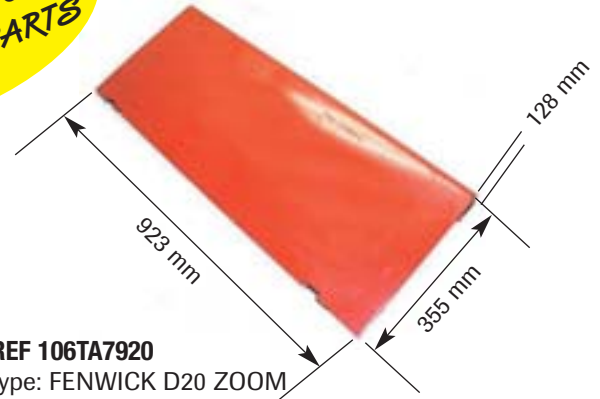

REF 106TA7920
type: FENWICK D20 ZOOM

USED FOR FENWICK

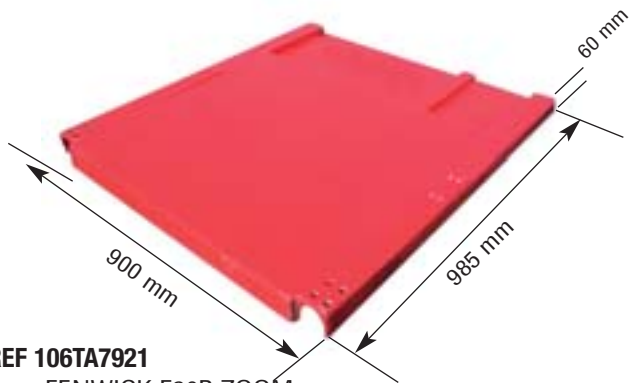

REF 106TA7921
type: FENWICK E30P ZOOM

USED FOR TOYOTA

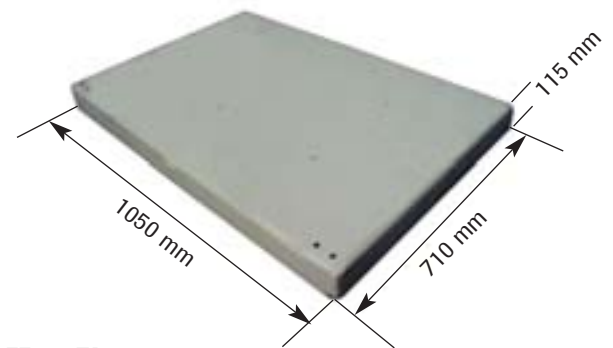

REF 106TA7922
type: TOYOTA 3FBE 15, 18, 20

ENGINE COVER HINGE USED FOR TOYOTA



REF 106TA7924
type: TOYOTA 5 SERIES



REF 106TA7923
type: TOYOTA 3 & 4 SERIES