

**REMA**®

## EURO connectors FT80:

Twin plug and socket connectors FT80 to Euro-standard EN 1175-1, 150V, 80A, IP23

### SOCKET - ON THE BATTERY



### Socket

(housing with female contacts, without aux. contacts)

16 mm<sup>2</sup> REF 105TA4681  
25 mm<sup>2</sup> REF 106TA9906

Length : 68 mm  
Width : 52 mm  
Height : 23 mm

### PLUG - VEHICLE/CHARGER



### Plug

(housing with male contacts, without aux. contacts)

16 mm<sup>2</sup> REF 105TA4680  
25 mm<sup>2</sup> REF 106TA9905

Length : 69 mm  
Width : 52 mm  
Height : 23 mm

### HANDLE



### Handle

REF 107TA7664

### CONTACTS



### Contacts

- FEMALE CONTACT**  
16 mm<sup>2</sup> REF 106TA9909  
25 mm<sup>2</sup> REF 106TA9910
- MALE CONTACT**  
16 mm<sup>2</sup> REF 106TA9907  
25 mm<sup>2</sup> REF 106TA9908

*sold per piece*

### AUX. CONTACT KITS



### Aux. contact kits

- FEMALE AUX. CONTACT KIT**  
REF 106TA9912
- MALE AUX. CONTACT KIT**  
REF 106TA9911

*sold per kit*

**REMA**®

## DIN connectors 80A:

Twin plug and socket connectors EN1175-1, DIN 43589, 150V, 80A, IP23

DIN CONNECTORS 80A

### SOCKET - ON THE BATTERY



### Black socket with fixed handle

(housing with female contacts, without aux. contacts)

16 mm<sup>2</sup>    **REF 112TA4818**  
 25 mm<sup>2</sup>    **REF 112TA4819**  
 35 mm<sup>2</sup>    **REF 123TA7591**

Length : 129 mm  
 Width : 101 mm  
 Height : 44 mm

### SOCKET - ON THE BATTERY



### Black socket

(housing with female contacts, without aux. contacts)

16 mm<sup>2</sup>    **REF 106TA9915**  
 25 mm<sup>2</sup>    **REF 106TA9916**  
 35 mm<sup>2</sup>    **REF 123TA7592**

Length : 74 mm  
 Width : 77 mm  
 Height : 24 mm

### PLUG - VEHICLE / CHARGER



### Black plug

(housing with male contacts, without aux. contacts)

16 mm<sup>2</sup>    **REF 106TA9913**  
 25 mm<sup>2</sup>    **REF 106TA9914**  
 35 mm<sup>2</sup>    **REF 123TA7593**

Length : 73 mm  
 Width : 77 mm  
 Height : 26 mm

### HANDLE



### Handle

**REF 107TA7665**



## PLUG - VEHICLE / CHARGER



## Red plug

**REMA**®

(housing with male contacts, without aux. contacts)

16 mm<sup>2</sup>    **REF 112TA4820**  
 25 mm<sup>2</sup>    **REF 112TA4821**

Length : 73 mm  
 Width : 77 mm  
 Height : 26 mm

## Red socket with fixed handle

(housing with female contacts, without aux. contacts)

16 mm<sup>2</sup>    **REF 112TA4945**  
 25 mm<sup>2</sup>    **REF 112TA4946**

Length : 129 mm  
 Width : 101 mm  
 Height : 44 mm

## CONTACTS

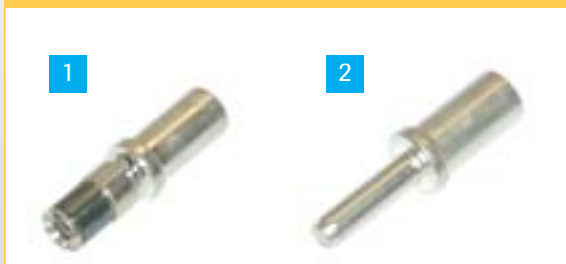

## Contacts

1. **FEMALE CONTACT**  
 16 mm<sup>2</sup>    **REF 106TA9919**  
 25 mm<sup>2</sup>    **REF 106TA9920**
2. **MALE CONTACT**  
 16 mm<sup>2</sup>    **REF 106TA9917**  
 25 mm<sup>2</sup>    **REF 106TA9918**

***sold per piece***

## AUX. CONTACT KITS



## Aux. contact kits

3. **FEMALE AUX. CONTACT KIT**  
**REF 106TA9922**
4. **MALE AUX. CONTACT KIT**  
**REF 106TA9921**
5. **FEMALE AUX. CONTACT KIT (for use with air supply)**  
**REF 123TA7594**
6. **MALE AUX. CONTACT KIT (for use with air supply)**  
**REF 123TA7595**

***sold per kit***

**REMA**®

## DIN connectors 160A:

Twin plug and socket connectors EN1175-1, DIN 43589, 150V, 160A, IP23

DIN CONNECTORS 160A

### SOCKET - ON THE BATTERY



### Socket with fixed handle

(housing with female contacts, without aux. contacts)

25 mm <sup>2</sup>	REF 106TA9926
35 mm <sup>2</sup>	REF 106TA9927
50 mm <sup>2</sup>	REF 106TA9928

Length : 165 mm
Width : 101 mm
Height : 61 mm

### Socket

(housing with female contacts, without aux. contacts)

25 mm <sup>2</sup>	REF 112TA4822
35 mm <sup>2</sup>	REF 112TA4823
50 mm <sup>2</sup>	REF 112TA4824

Length : 103 mm
Width : 90 mm
Height : 31 mm

### PLUG - VEHICLE/CHARGER



### Plug

(housing with male contacts, without aux. contacts)

25 mm <sup>2</sup>	REF 106TA9923
35 mm <sup>2</sup>	REF 106TA9924
50 mm <sup>2</sup>	REF 106TA9925

Length : 97 mm
Width : 90 mm
Height : 34 mm

### Handle

REF 106TA9937

### CONTACTS

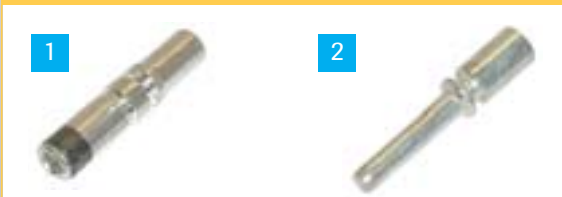

### Contacts

*sold per piece*

<b>1. FEMALE CONTACT</b>	<b>2. MALE CONTACT</b>
25 mm <sup>2</sup> REF 106TA9932	25 mm <sup>2</sup> REF 106TA9929
35 mm <sup>2</sup> REF 106TA9933	35 mm <sup>2</sup> REF 106TA9930
50 mm <sup>2</sup> REF 106TA9934	50 mm <sup>2</sup> REF 106TA9931

### AUX. CONTACT KITS



### Aux. contact kits

*sold per kit*

<b>3. FEMALE AUX. CONTACT KIT</b> REF 106TA9936	<b>4. MALE AUX. CONTACT KIT</b> REF 106TA9935
<b>5. FEMALE AUX. CONTACT KIT</b> for use with air supply REF 123TA7596	<b>6. MALE AUX. CONTACT KIT</b> for use with air supply REF 123TA7595

**REMA**®

## DIN connectors 320A:

Twin plug and socket connectors EN1175-1, DIN 43589, 150V, 320A, IP23

### SOCKET - ON THE BATTERY



### Socket with snap handle

(housing with female contacts, without aux. contacts)

50 mm<sup>2</sup> REF 112TA4825  
70 mm<sup>2</sup> REF 112TA4826  
95 mm<sup>2</sup> REF 112TA4827

Length : 165 mm  
Width : 101 mm  
Height : 78 mm

### Socket

(housing with female contacts, without aux. contacts)

50 mm<sup>2</sup> REF 106TA9940  
70 mm<sup>2</sup> REF 105TA4683  
95 mm<sup>2</sup> REF 106TA9941

Length : 129 mm  
Width : 92 mm  
Height : 38 mm

### PLUG - VEHICLE/CHARGER



### Plug

(housing with male contacts, without aux. contacts)

50 mm<sup>2</sup> REF 105TA4682  
70 mm<sup>2</sup> REF 106TA9938  
95 mm<sup>2</sup> REF 106TA9939

Length : 129 mm  
Width : 92 mm  
Height : 40 mm

### Handle

REF 106TA9937

### CONTACTS



### Contacts

*sold per piece*

#### 1. FEMALE CONTACT

50 mm<sup>2</sup> REF 106TA9945  
70 mm<sup>2</sup> REF 106TA9946  
95 mm<sup>2</sup> REF 106TA9947

#### 2. MALE CONTACT

50 mm<sup>2</sup> REF 106TA9942  
70 mm<sup>2</sup> REF 106TA9943  
95 mm<sup>2</sup> REF 106TA9944

### AUX. CONTACT KITS



### Aux. contact kits

*sold per kit*

#### 3. FEMALE AUX. CONTACT KIT

REF 106TA9949

#### 4. MALE AUX. CONTACT KIT

REF 106TA9948

#### 5. FEMALE AUX. CONTACT KIT

for use with air supply  
REF 123TA7597

#### 6. MALE AUX. CONTACT KIT

for use with air supply  
REF 123TA7598





**SOCKET (FEMALE) WITH AIR SUPPLY SYSTEM AND HANDLE**

air



**PLUG (MALE) WITH AIR SUPPLY SYSTEM**

air



**DIN connectors IP23 with air supply system:**

**SOCKET (FEMALE):**



**Compl. connector (housing + adaptor + handle + contact set)**

Cable size mm <sup>2</sup>	REF 80 A	REF 160 A	REF 320 A
16	106TA9965		
25	106TA9966	106TA9974	
35		106TA9967	
50		105TA4684	106TA9975
70			106TA9976
<b>Blue adaptor:</b>	106TA9968	106TA9977	106TA9982
<b>Aux. contact (2 pieces):</b>	123TA7594	123TA7596	123TA7597

**PLUG (MALE):**

**Compl. connector (housing + adaptor + contact set)**

Cable size mm <sup>2</sup>	REF 80 A	REF 160 A	REF 320 A
16	106TA9970		
25	106TA9971	106TA9978	
35		106TA9979	
50		106TA9980	106TA9984
70			106TA9985
<b>Blue adaptor:</b>	106TA9972	106TA9981	106TA9986
<b>Aux. contact (2 pieces):</b>	123TA7595	123TA7595	123TA7598

Remark: the main contacts and handles are interchangeable with the standard DIN connectors.

**BATTERY CONNECTORS FOR EZGO GOLF CARS**



REF 124TA2655  
Plug kit



REF 124TA2656  
Plug kit



**DIN CONNECTORS IP65:**

- These battery connectors are totally protected against ingress of dust and low pressure water jets.
- Certificate; ISSEP PV8059

**SOCKET (FEMALE)**



REF 112TA4828  
160 A

REF 112TA4829  
320 A

**PLUG (MALE)**



REF 112TA4830  
160 A

REF 112TA4831  
320 A



## ANDERSON DIN-connectors:

TWIN PLUG SOCKET CONNECTORS EN1175-1, DIN 43589, 150V, IP23

A COMPLETE RANGE OF ANDERSON CONNECTORS IS NOW AVAILABLE. PLEASE CONTACT US FOR MORE INFORMATION

### EBC 80 AMP

COMPLETE CONNECTORS (Housing with 2 contacts, without aux contacts)

#### PLUG



REF 116TA6045  
16mm<sup>2</sup>  
REF 116TA6046  
25mm<sup>2</sup>

#### SOCKET



REF 116TA6047  
16mm<sup>2</sup>  
REF 116TA6048  
25mm<sup>2</sup>

HANDLE: 116TA6049  
MAIN CONTACTS (SOLD PER PIECE)

Wire Size	Pin contact	Socket contact
16mm <sup>2</sup>	REF 116TA6050	REF 116TA6052
25mm <sup>2</sup>	REF 116TA6051	REF 116TA6053



ANDERSON DIN-CONNECTORS

### EBC 160 AMP

COMPLETE CONNECTORS (Housing with 2 contacts, without aux contacts)

#### PLUG



REF 116TA6054  
25mm<sup>2</sup>  
REF 116TA6055  
35mm<sup>2</sup>  
REF 116TA6056  
50mm<sup>2</sup>

#### SOCKET



REF 116TA6057  
25mm<sup>2</sup>  
REF 116TA6058  
35mm<sup>2</sup>  
REF 116TA6059  
50mm<sup>2</sup>

HANDLE: 116TA6060  
MAIN CONTACTS (SOLD PER PIECE)

Wire Size	Pin contact	Socket contact
25mm <sup>2</sup>	REF 116TA6061	REF 116TA6064
35mm <sup>2</sup>	REF 116TA6062	REF 116TA6065
50mm <sup>2</sup>	REF 116TA6063	REF 116TA6066



### EBC 320 AMP

COMPLETE CONNECTORS (Housing with 2 contacts, without aux contacts)

#### PLUG



REF 116TA6067  
50mm<sup>2</sup>  
REF 116TA6068  
70mm<sup>2</sup>

#### SOCKET



REF 116TA6069  
50mm<sup>2</sup>  
REF 116TA6070  
70mm<sup>2</sup>

HANDLE: 116TA6071  
MAIN CONTACTS (SOLD PER PIECE)

Wire Size	Pin contact	Socket contact
50mm <sup>2</sup>	REF 116TA6072	REF 116TA6074
70mm <sup>2</sup>	REF 116TA6073	REF 116TA6075





## TYPE ANDERSON



## Battery connector type Y:

## Type ANDERSON



Fig	Type	Wire size mm <sup>2</sup>	REF
1+2	Plug (aluminium) with contact set	70	106TA9959
2	Contact set	70	106TA9960
3+4	Plug (polycarbonate) with contact set	70	106TA9961
4	Contact set	70	106TA9962
5+6	Receptacle (with contact set)	70	106TA9963
6	Contact set	70	106TA9964

## USED FOR FENWICK



## Used for FENWICK

Fig	Type	Wire size mm <sup>2</sup>	REF
7+8	Plug (aluminium) with contact set	50	106TA9950
8	Contact set	50	106TA9951
9	Aux. contact set		106TA9952
10+11	Receptacle (rubber) with contact set	50	106TA9953
11	Contact set	50	106TA9954
12	Aux. contact set		106TA9955
13+14	Receptacle with contact set	50	106TA9956
14	Contact set	50	106TA9957
15	Aux. contact set		106TA9958

## ON THE BATTERY



## Battery connectors used for "BALKANCAR"

Amp.	Wire size (mm <sup>2</sup> )	REF
100 A	25	112TA4834
200 A	35	112TA4836
300 A	50	112TA4838

## VEHICLE / CHARGER



Amp.	Wire size (mm <sup>2</sup> )	REF
100 A	25	112TA4835
200 A	35	112TA4837
300 A	50	112TA4839





## Battery connector type Y:

### Type "REMA" (polyamide)



#### Complete connector: (housing and contacts)

Fig	Type	Nominal	Destination amperage	Wire size	REF
1	Plug (male)	160 A	battery	35 mm <sup>2</sup>	106TA9988
		200 A	battery	50 mm <sup>2</sup>	105TA4686



2	Socket (female) Fixing holes distance : 82,6 x 48 mm and 80 x 35 mm	160 A	truck	35 mm <sup>2</sup>	106TA9989
		200 A	truck	50 mm <sup>2</sup>	105TA4687



3	Charger socket (female)	160 A	charger	35 mm <sup>2</sup>	106TA9990
		200 A	charger	50 mm <sup>2</sup>	105TA4688



#### Complete connector: (housing and contacts)

Fig	Type	Nominal	Destination amperage	Wire size	REF
4	Socket (female)	160 A	battery	35 mm <sup>2</sup>	106TA9991
		200 A	battery	50 mm <sup>2</sup>	106TA9992



5	Plug (male) Fixing holes distance: 82,6 x 48 mm	160 A	truck	35 mm <sup>2</sup>	106TA9993
		200 A	truck	50 mm <sup>2</sup>	106TA9994



5	Plug (male) Fixing holes distance: 80 x 35 mm	160 A	truck	35 mm <sup>2</sup>	106TA9995
		200 A	truck	50 mm <sup>2</sup>	106TA9996

6	Charger plug (male)	160 A	charger	35 mm <sup>2</sup>	106TA9997
		200 A	charger	50 mm <sup>2</sup>	106TA9998



**Remark:** These connectors are supplied with crimpable contacts

**Separate contacts:** see next page

**CONTACT PIN MALE****CONTACT PIN FEMALE****TYPE RAVIOLI****Battery connectors type Y:****Contact pin male (for type 1, 5 and 6 - see previous page)**

Type	Cable size	REF
Crimp	35 mm <sup>2</sup>	<b>106TA1005</b>
	50 mm <sup>2</sup>	<b>106TA1006</b>
Solder	35 mm <sup>2</sup>	<b>107TA1004</b>
	50 mm <sup>2</sup>	<b>107TA1005</b>

**Contact tube female (for type 2, 3 and 4 - see previous page)**

Type	Cable size	REF
Crimp	35 mm <sup>2</sup>	<b>107TA1006</b>
	50 mm <sup>2</sup>	<b>106TA1010</b>
Solder	35 mm <sup>2</sup>	<b>106TA1011</b>
	50 mm <sup>2</sup>	<b>106TA1012</b>

**Type "RAVIOLI":****Complete connector (housing + contact set):**

Fig	Type	Cable size	REF
1 + 3	Socket (female)	50 mm <sup>2</sup>	<b>106TA9999</b>
2 + 4	Plug (male)	50 mm <sup>2</sup>	<b>107TA7675</b>

**Contact set:**

3	Female	50 mm <sup>2</sup>	<b>107TA1001</b>
4	Male	50 mm <sup>2</sup>	<b>107TA1002</b>

**Aux. contact set:**

No photo	Aux. (female)		<b>106TA1003</b>
No photo	Aux. (male)		<b>107TA1003</b>

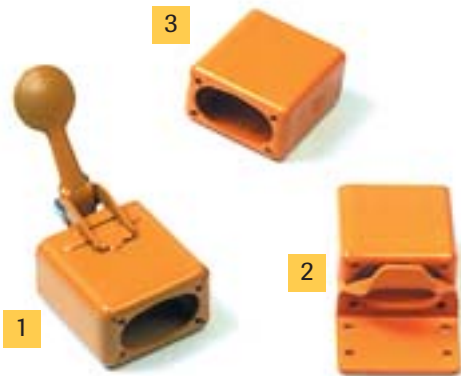

## CONNECTORS TYPE E

BATTERY CONNECTOR  
"SCHALTBAU" TYPE LZ

## Connectors type E

Complete connectors: (housing + contacts)

Fig	Type	Wire size AWG	Wire size mm <sup>2</sup>	REF
1+4+6	Locking half	2/0	70	106TA1018
2+4+6	Mounting half	2/0	70	106TA1019
3+4+6	Charging half	2/0	70	106TA1020
1	Locking half			106TA1021
2	Mounting half			106TA1022
3	Charging half			106TA1023

Contact sets:

Fig	Wire size AWG	Wire size mm <sup>2</sup>	REF
4	2	35	106TA1024
	2/0	70	106TA1025
	4/0	107	106TA1026

Auxiliary contact set:

Fig	Wire size AWG	Wire size mm <sup>2</sup>	REF
5	14	2,5	106TA1027

Accessories:

Fig	Type	REF
6	Insulation block	107TA1009
7	Cable clamp	106TA1029
8	Cable gland	106TA1030

## Battery connector "SCHALTBAU" type LZ:

Fig	Type	REF
9	Housing	106TA1013
10	Handle	107TA1007
11	Contact set	107TA1008
12	Aux. contact set (male)	106TA1016
13	Aux. contact set (female)	106TA1017

**BATTERY CONNECTORS  
"BERG" CAST ALUMINIUM**

1



2



3



4



5



6

**Battery connectors "BERG" cast  
aluminium**

Fig	Type	Amp.	DIN	REF
1	Charging connector with handle with bushes (female)	160 A 125 A	43584 43586	<b>105TA4689</b> <b>106TA1037</b>
2	Charging plug with contact pins (male)	160 A	43581	<b>105TA4690</b>
3	Built-in charging appliance inlet with contact pins (male)	160 A 125 A	43584 43586	<b>106TA1041</b> <b>106TA1042</b>
4	Built-in charging outlet with contact bushes (female)	160 A 125 A	43581 43571	<b>106TA1038</b> <b>107TA1014</b>
5	Charging plug inserts (male)	160 A 125 A		<b>106TA1043</b> <b>106TA1044</b>
6	Charging socket (female)	160 A 125 A		<b>106TA1045</b> <b>106TA1046</b>



**CONNECTORS TYPE "CABLEFORM"**



**Connectors type "CABLEFORM"**

Fig	Colour	Wire size	REF
1	red	50 mm <sup>2</sup>	106TA1059
2	black	50 mm <sup>2</sup>	106TA1060

**CONNECTORS USED FOR TYPE "BT"**



**Connectors used for type "BT"**

Fig	Type	REF
3	female connector	106TA1057
4	male connector	106TA1058

**SINGLE-POLE CONNECTORS TYPE BK "SCHALTBAU"**



**Single pole connectors "SCHALTBAU" type BK**

Fig	Type	Cable size	REF
5	female (+ pole)	95 mm <sup>2</sup>	106TA1051
6	female (- pole)	95 mm <sup>2</sup>	106TA1052
7	male (+ pole)	95 mm <sup>2</sup>	106TA1053
8	male (- pole)	95 mm <sup>2</sup>	106TA1054
9	male flange (+ pole)	95 mm <sup>2</sup>	106TA1055
10	male flange (- pole)	95 mm <sup>2</sup>	106TA1056

**CONNECTORS USED FOR TCM FORKLIFTS**



**Connectors used for JAPANESE forklifts:**

Fig	Type	REF
11	4-pole 20 A - 250 V	106TA1049
12	4-pole 30 A - 250 V	107TA1016

**CONNECTORS USED FOR TOYOTA FORKLIFTS**



**Connectors used for JAPANESE forklifts:**

Fig	Type		REF
13	female	4-pole 30 A - 250 V	112TA4832
14	female	5-pole 30 A - 250 V	106TA1047
15	male	4-pole 30 A - 250 V	106TA1048
16	male	5-pole 30 A - 250 V	112TA4833

CABLEFORM - BT - SCHALTBAU BK - JAPANESE CONNECTORS





## EX-PROOF connectors :

Flame proof single-pole connector in conformity with EN 50014 and 50019, 250 V, 200 A

### EX PLUG



	Plug positive	Plug negative
50 mm <sup>2</sup>	REF 112TA4947	REF 112TA4840
70 mm <sup>2</sup>	REF 112TA4948	REF 112TA4841

Max. length :	136 mm
Max. Ø :	50 mm
Max. weight :	330 g

### EX PLUG WITH CODING SYSTEM

	Plug positive	Plug negative
50 mm <sup>2</sup>	REF 112TA4949	REF 112TA4842
70 mm <sup>2</sup>	REF 112TA4950	REF 112TA4843

Max. length :	136 mm
Max. Ø :	50 mm
Max. weight :	330 g

### EX SOCKET WITH SCREW-CONNECTION



M12	REF 112TA4844
-----	---------------

Max. length :	76 mm
Max. Ø :	50 mm
Max. weight :	195 g

### EX SOCKET WITH SCREW-CONNECTION, WITH CODING SYSTEM

M12	REF 112TA4845
-----	---------------

Max. length :	76 mm
Max. Ø :	50 mm
Max. weight :	195 g

### ACCESSORY



ASSEMBLY TOOL FOR SOCKET	REF 112TA4846
--------------------------	---------------

## UNIVERSAL TRAILER PLUG

Synthetic housing:  
5 pole DIN 72576 (ISO 1724)  
7 pole DIN 72577 (ISO 1724)

**REF 106TA6330**  
**REF 106TA6331**

Metal housing:  
5 pole DIN 72576 (ISO 1724)  
7 pole DIN 72577 (ISO 1724)

**REF 106TA6332**  
**REF 106TA6333**

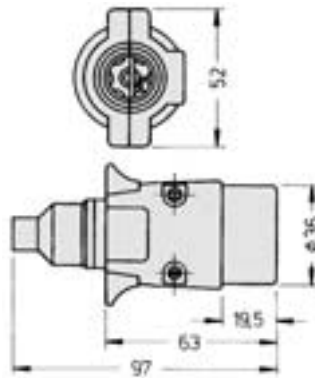

## UNIVERSAL TRAILER SOCKET

Synthetic housing:  
5 pole DIN 72576 (ISO 1724)  
7 pole DIN 72577 (ISO 1724)

**REF 106TA6334**  
**REF 106TA6335**

Metal housing:  
5 pole DIN 72576 (ISO 1724)  
7 pole DIN 72577 (ISO 1724)

**REF 106TA6336**  
**REF 106TA6337**

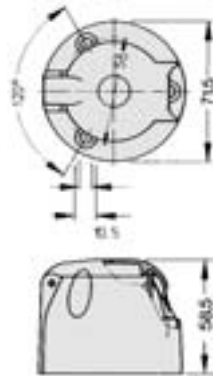

## UNIVERSAL TEST KIT FOR TRAILER SOCKET (12 VOLT / 7 POLE)



## REF 124TA2765

- 1 test plug for testing the trailer wiring inclusive the trailer lighting (battery included) (1 person)
- 1 test plug for testing the wiring of the trailer socket (2 persons)





**CONNECTOR SAVER**

**Potential problem:**

Inadvertent damage to connectors and cabling results in high cost repairs and replacements. Damaged cable is a fire and safety hazard.

*The connector saver offers a simple and inexpensive solution to a problem common to all users of electric trucks.*

**Answer:**

This is the only solution that retracts the cable safely whilst at the same time ensuring that there is virtually no tension on the battery connection during the charging operation. The complete kit with installation instructions includes: cable balance - cable clamp - wall bracket and fixings (several types available)

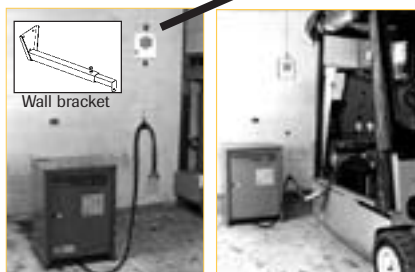

Pull back force	Cable length	REF
1,8 kg	1,6 m	<b>107TA1017</b>
2,7 kg	2,0 m	<b>107TA1018</b>
3,6 kg	2,0 m	<b>107TA1019</b>
4,5 kg	2,4 m	<b>107TA1020</b>
6,8 kg	2,4 m	<b>107TA1021</b>

1,8 or 2,7 kg. pull back force is adequate for most applications.

**CABLE REWINDER**

• Safety: With a cable rewriter mounted in the charging bay it is easier to avoid accidents which otherwise could happen if cables were left laying on the floor after charging.

*Keep the charging bay well organized with the special cable rewriter.*



Description	REF
Cable rewriter 16 mm <sup>2</sup> without connector	<b>105TA4851</b>
Cable rewriter 25 mm <sup>2</sup> without connector	<b>107TA1022</b>
Cable rewriter 35 mm <sup>2</sup> without connector	<b>107TA1023</b>



## TYPE A



W x H x L  
130 x 100 x 117 mm

## TYPE B



W x H x L  
122 x 109 x 238 mm

## TYPE C



W x H x L  
180 x 135 x 356 mm

## TYPE D



W x H x L  
65 x 23 x 75 mm

## TYPE E



W x H x L  
128 x 50 x 138 mm

## TYPE F



W x H x L  
77 x 70 x 161 mm



DC/DC CONVERTERS

*Several models are available, with an OUTPUT VOLTAGE of 12 V or 24 V and an OUTPUT CURRENT of 5 Amps up to 62 Amps.*

Some features:

- Regulated output voltage.
- Fully isolated output.
- Short-circuit protection.
- Large cooling heatsink.
- High efficiency.

DC/DC CONVERTER HIGH INPUT - LOW OUTPUT	OUTPUT PERFORMANCE	TYPE	REF
DC DC 24 - 12	5 A 60 W	type D	107TA1024
DC DC 24 - 12	20 A 240 W	type E	119TA8980
DC DC 24 - 12	30 A 360 W	type E	123TA7621
DC DC 36 - 12	33 A 400 W	type B	106TA1071
DC DC 48 - 12	10 A 120 W	type F	111TA4013
DC DC 48 - 12	20 A 240 W	type A	106TA1074
DC DC 48 - 12	40 A 500 W	type B	106TA1075
DC DC 48 - 12	62 A 750 W	type C	107TA1028
DC DC 48 - 24	5 A 120 W	type F	111TA4014
DC DC 48 - 24	10 A 240 W	type A	111TA3905
DC DC 48 - 24	20 A 500 W	type B	106TA1079
DC DC 48 - 24	31 A 750 W	type C	107TA1031
DC DC 72 - 12	10 A 120 W	type F	107TA1032
DC DC 72 - 12	20 A 240 W	type A	112TA1151
DC DC 72 - 24	5 A 120 W	type F	111TA4015
DC DC 72 - 24	10 A 240 W	type A	112TA1152
DC DC 80 - 12	10 A 120 W	type F	111TA4016
DC DC 80 - 12	20 A 240 W	type A	106TA1085
DC DC 80 - 12	40 A 500 W	type B	106TA1086
DC DC 80 - 12	62 A 750 W	type C	107TA1034
DC DC 80 - 24	5 A 120 W	type F	111TA4017
DC DC 80 - 24	10 A 240 W	type A	106TA1088
DC DC 80 - 24	20 A 500 W	type B	106TA1089
DC DC 80 - 24	31 A 750 W	type C	107TA1035
DC DC 80 - 48	10 A 500 W	type B	107TA1039
DC/DC CONVERTER LOW INPUT - HIGH OUTPUT	OUTPUT PERFORMANCE	TYPE	REF
DC DC 12 - 24	6 A 150 W	type A	112TA1153
DC DC 12 - 24	10 A 240 W	type B	112TA1154





## NOISE FILTER



REF 111TA3906

As an option we recommend the installation of a voltage regulator for vehicles with impulse control and a motor output of 20 KW. This regulator must be incorporated between the supply voltage of the electro-vehicle and the DC/DC converter. In this way noise and disturbance peaks are suppressed and an undisturbed and reliable running of the converter is ensured.

**Specifications:**

<b>Input voltage</b>	<b>15 V - 100 V</b>
<b>Output voltage</b>	<b>15 V - 100 V</b>
<b>Output current</b>	<b>7A</b>
<b>Insulation voltage</b>	<b>&gt; 1,5 KV</b>
<b>Temperature range</b>	<b>-25°C / +60°C</b>

## DC/DC - CONVERTER USED FOR STEINBOCK/KOMATSU



REF 111TA3907

Dimensions : 85 x 52,4 x 130 mm

Efficiency up to 96%  
 Protected against thyristor-caused noise  
 Sealed unit with shockproof design  
 Parallel connectable  
 Reverse-polarity protection  
 Short-circuit protection  
 Overvoltage protection by transient suppressor  
 Ripple  $\leq 100\text{mVss}$  / Spikes  $\leq 200\text{mVss}$   
 Load regulation stat  $<0,5\%$ , dyn.  $<2\%$   
 Natural convection  
 Metal package, screw mountable

**Specifications:**

• Input	<b>38 - 96 VDC</b>
• Output	<b>24 VDC</b>
• Output performance	<b>5A - 120 W</b>

**Accessories :**

- Mating connector 4 pole : REF 111TA3908
- Mating pins 0,5 -2,1 mm<sup>2</sup>: REF 106TA9560

## DC/DC - CONVERTER USED FOR STILL/WAGNER/JUNGHEINRICH



REF 111TA3909

Dimensions : 90 x 37 x 90 mm

**Specifications:**

• Input	<b>28 - 100 VDC</b>
• Output	<b>24 VDC</b>
• Output performance	<b>13A - 300 W</b>



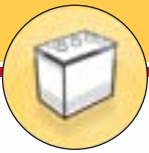
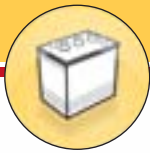

**DC/DC - CONVERTER USED FOR LINDE**

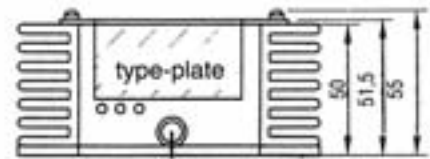
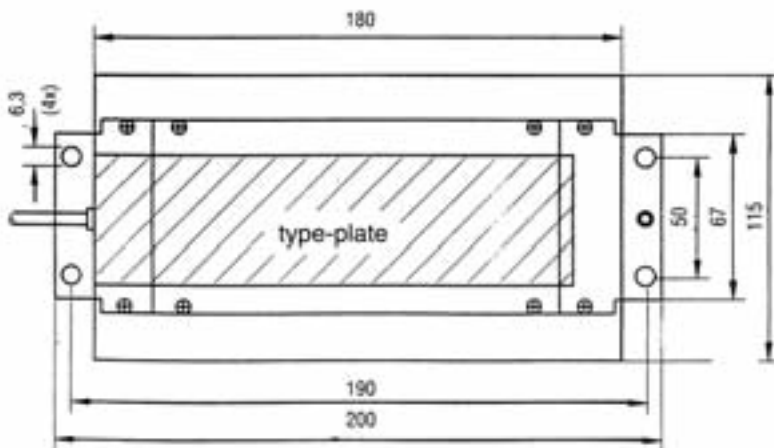

DC/DC CONVERTERS

REF 111TA3910

Specifications:

Input 57 - 150 VDC (80VDC)  
 Output 13,8 VDC  
 Output performance 18 A - 250 W



REF 111TA3911

Specifications:

Input 33 - 93 VDC (48VDC)  
 Output 13,8 VDC  
 Output performance 18 A - 250 W



**CURTIS - DC/DC - CONVERTERS**

**1 YEAR  
REPLACEMENT  
WARRANTY**

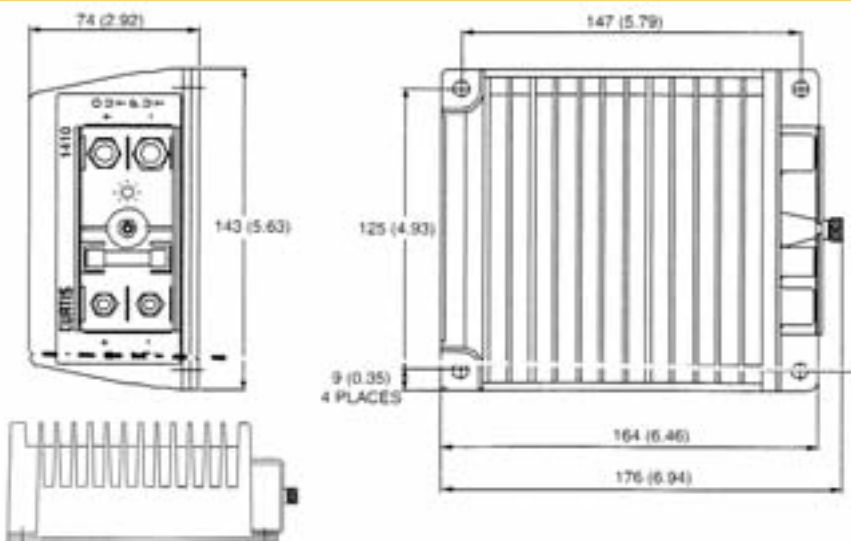

**DESCRIPTION**

The 1400 Series dc/dc Converter applies advanced technology and is configured specifically for electric vehicles. Available in a range of 200W and 300W, the devices provide a precise regulated output of 12.0 or 24.0 volts for computer terminals and communication equipment. Provides 13.5 or 28.0 volts for driving lamps and charging auxiliary batteries.

INPUT	OUTPUT	OUTPUT PERFORMANCE	REF
24/36	12	25 A - 300 W	111TA3912
48/60	12	25 A - 300 W	111TA3913
	24	12,5 A - 300 W	111TA3914
72/96	12	25 A - 300 W	111TA3915
	28	12,5 A - 300 W	111TA3916

## DC/DC - CONVERTER USED FOR CLARK

DC/DC CONVERTERS



**Dimensions :**  
143 x 80 x 150 mm

**REF 115TA4707****Specifications:**

Input	48 VDC
Output	12 VDC
Output performance	240 W

**REF 115TA6866****Specifications:**

Input	80 VDC
Output	12 VDC
Output performance	240 W

## DC/AC POWER INVERTERS

## Technical specifications :

- Output voltage : 230 VAC
- Input voltage : 12 VDC
- ON/OFF switch
- Low voltage protection :  
If the voltage drops below 10,5V an alarm will sound.  
Below 9,8 V the inverter will automatically shut down.
- High voltage protection :  
The inverter shuts down if the voltage exceeds 15,6 V.
- High temperature protection :  
if the internal temperature exceeds 70°C, the inverter will shut down. After a certain cooling period, the inverter can be restarted.
- Overload protection :  
the inverter automatically shuts down if the maximum capacity is exceeded with approx. 20%.
- Short-circuit protection : all inverters have a replaceable fuse which will protect the inverter against wrong polarity or short circuit.



Max. continuous power (W)	Surge (capacity W)	Dimensions mm H x L x W	REF
200	400	166 x 126 x 52	115TA6931
400	800	209 x 126 x 52	115TA6932



Max. continuous power (W)	Surge (capacity W)	Dimensions mm	REF
600	1200	225 x 169 x 61	115TA6933
800	1600	295 x 169 x 61	115TA7008
1000	2000	370 x 169 x 61	115TA6934
1200	2400	370 x 169 x 61	115TA7009



Max. continuous power (W)	Surge (capacity W)	Dimensions mm	REF
1500	3000	428 x 208 x 76	115TA7010
2000	3500	460 x 208 x 76	115TA7011
2500	4500	460 x 208 x 148	123TA7582
3000	5000	460 x 208 x 148	123TA7583



## ACCESSORY :

## REF 115TA6975

Universal adaptor for use in UK, USA, Denmark, Switzerland, Middle East, South America, Russia, Germany, Egypt, Italy, Australia and Taiwan.



75 A - 200 A (5 SEC.)

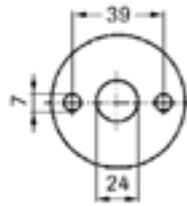

Switch with 2 keys  
Separate keys are available, please specify your keynumber.



Plastic switch (with key) **REF 123TA7672**

100 A - 500 A (5 SEC.) 1-POLE (2 CONNECTIONS)

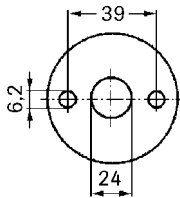

**REF 107TA1095**  
plastic key - 1 side pin

Plastic switch (with key) **REF 106TA1187**



**REF 106TA1188**  
metal key

Metal switch (with key) **REF 106TA1189**

150 A - 1000 A (5 SEC.) 1-POLE (2 CONNECTIONS)

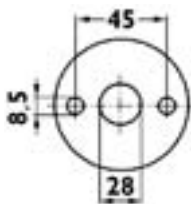

Switch **REF 111TA3917**



Switch with independent SM aux. contact  
**REF 112TA4853**

250 A - 2500 A (5 SEC.) 1-POLE (2 CONNECTIONS)

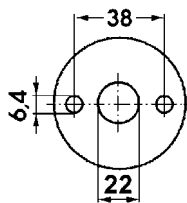

Switch (with key) **REF 106TA1184**



**REF 107TA1095**  
Key - 1 side pin



**REF 107TA1094**  
Key - 2 side pins



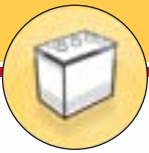
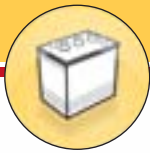

BATTERY SWITCHES

**250 A CONTINUOUS - 2500 A (5 SEC.) 1-POLE (2 CONNECTIONS)**

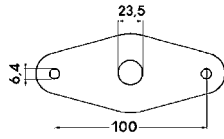

Key REF 107TA1092

Switch (with key) REF 106TA1183

**250 A - 2500 A (5 SEC.) 2-POLE (4 CONNECTIONS)**

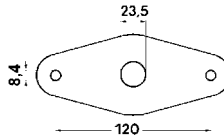

Key REF 107TA1092

Switch (with key) REF 107TA1093

**300 A - 2500 A (5 SEC.) 1-POLE (2 CONNECTIONS)**

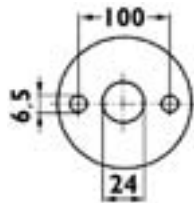

Switch REF 111TA3918

**600 A CONTINUOUS - 4500 A (5 SEC.) 1-POLE (2 CONNECTIONS)**

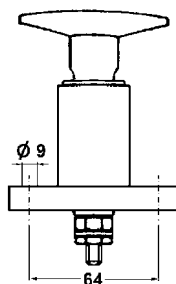

Switch REF 107TA1096





## ACCESSORY

**REF 107TA1097**

Little chain to connect the key to the switch  
(± 20 cm)

## 2-POLE SWITCHES TO DISCONNECT BATTERY- AND FIELD CIRCUIT

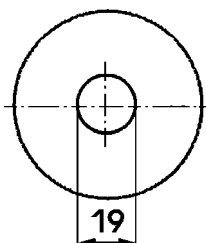

Large studs 125 A continuous  
1000 A (5 sec)

**REF 106TA1191**

Small studs 20 A continuous

Fits panels up to thickness of 5 mm

## 2-POLE SWITCHES TO DISCONNECT BATTERY- AND FIELD CIRCUIT

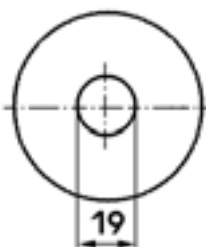

Large studs 125 A continuous  
1000 A (5 sec)

**REF 106TA1190**

Small studs 20 A continuous

Fits panels up to thickness of 23 mm